

# Tunstall

## Lifeline Smart Hub™ & Device Management Platform



### Smart Hub Reference Guide

# Contents

- Contents..... 2
- Appendices ..... 4
- 1 Introduction ..... 1**
  - 1.1 Document purpose.....1
  - 1.1.1 Versions .....1
  - 1.2 Overview.....1
  - 1.2.1 Smart Hub communication methods.....1
  - 1.3 Typographical conventions.....3
  - 1.4 Related documents.....3
- 2 What’s in the Smart Hub box..... 4**
  - 2.1 The Smart Hub.....5
    - 2.1.1 Front/top view .....5
    - 2.1.2 Rear view .....5
    - 2.1.3 Base view .....5
  - 2.2 Warning/status lights on the Smart Hub.....6
  - 2.3 Personal radio trigger .....8
- 3 Installing the Smart Hub ..... 9**
  - 3.1 Stage 1 – Determine the location of the Smart Hub .....9
  - 3.2 Stage 2 – Connect leads and power up the Smart Hub..... 10
    - 3.2.1 Connect the optional Ethernet cable .....10
    - 3.2.2 Connect the mains power adaptor .....10
  - 3.3 Stage 3 – Check use of the internal antenna..... 11
  - 3.4 Stage 4 – Confirm the cellular signal strength..... 11
  - 3.5 Stage 5 – Set up the external cellular antenna..... 12
  - 3.6 Stage 6 – Prepare sensors for use as the virtual property exit sensor..... 13
  - 3.7 Stage 7 – Register personal triggers/telecare sensors ..... 13
  - 3.8 Stage 7 – Test the range of personal triggers/telecare sensors..... 14
  - 3.9 Stage 8 – Connect hardwired devices ..... 15
    - 3.9.1 Connect a hardwired input device.....15
    - 3.9.2 Connect a hardwired output device .....16
  - 3.10 Stage 9 – Fit the Smart Hub in the required location..... 16
    - 3.10.1 External antenna.....16
    - 3.10.2 Wall mounting with pattress .....17

3.10.3	Wall mounting without pattress.....	18
3.10.4	Fitting the table stand.....	19
<b>4</b>	<b>Configuring the Smart Hub .....</b>	<b>21</b>
4.1	Stage 1 – Log on to DMP and access the configuration settings.....	22
4.2	Stage 2 – Configure the time zone .....	25
4.3	Stage 3 – Configure speech message settings.....	26
4.4	Stage 4 – Configure pendant signalling during an alarm call .....	27
4.5	Stage 5 – Configure IP data communications settings .....	28
4.6	Stage 6 – Configure monitoring centre settings.....	29
4.7	Stage 7 – Register and configure personal triggers and telecare sensors .....	32
4.8	Stage 8 – Configure the virtual property exit sensor .....	35
4.9	Stage 9 – Configure ambient temperature monitoring.....	36
4.10	Stage 10 – Configure inactivity monitoring.....	37
4.11	Stage 11 – Configure hardwired input.....	38
4.12	Stage 12 – Configure Cancel At Source feature.....	38
4.13	Stage 13 – Configure events.....	41
4.14	Stage 14 – Configure event suppression .....	43
4.15	Stage 15 – Configure the Home or Away feature.....	44
4.16	Stage 16 – Configure periodic calls.....	45
4.17	Stage 17 – Configure power fault monitoring settings .....	49
4.18	Stage 18 – Configure line ringing settings .....	50
4.19	Stage 19 – Configure DMP update announcements .....	50
4.20	Stage 20 – Save changes to DMP.....	51
<b>5</b>	<b>Testing the installation .....</b>	<b>53</b>
5.1	Stage 1 – Test the range of personal triggers/telecare sensors registered using DMP .....	53
5.2	Stage 2 – Test alarm calls .....	53
5.3	Stage 3 – Test virtual property exit sensor.....	54
5.4	Stage 4 – Test hardwired output.....	54
5.5	Stage 5 – Ready to use.....	54

# Appendices

A	Powering down the Smart Hub .....	55
B	Smart Hub announcements.....	56
C	Status of the Smart Hub .....	60
D	Applying a template to a device .....	62
E	DMP online help.....	64
F	List of supported triggers/sensors .....	65
G	List of typical default Smart Hub event settings .....	66
H	Technical data .....	69
H.1	Battery information .....	69
H.2	Technical details – Europe.....	69
H.3	Technical details – Australia .....	70
I	Glossary.....	71
J	Contact details .....	74

# 1 Introduction

## 1.1 Document purpose

This document is intended to guide an installer through the process of installing and configuring the Smart Hub ready for use. It is split into four main sections:

1. The Lifeline Smart Hub™ itself – including physical appearance, sockets and ports, standard radio peripherals and indicators.
2. Step-by-step guide to physically installing the Smart Hub unit.
3. Step-by-step guide to configuring the Smart Hub using DMP.
4. Step-by-step guide to testing the Smart Hub once physically installed and configured.

It is assumed that the installer has familiarity with telecare alarm units and has received appropriate training specific to the Smart Hub and DMP.

### 1.1.1 Versions

This document reflects DMP version 2.9.9.1 and Smart Hub firmware version 5.10.4 and related configuration schema version 5.10.2

## 1.2 Overview

The Lifeline Smart Hub is Tunstall's latest home unit. Able to communicate using digital (IP) protocols over cellular/mobile networks and fixed line broadband, it opens a new world of possibilities for the provision of care in the home.

The Lifeline Smart Hub retains core functionality from Tunstall's existing and past Lifeline products, enabling users to access help 24 hours a day by pressing a button on the unit, or from elsewhere in their home by using a radio pendant worn on the wrist or neck. The call is answered by specially trained monitoring centre operators, who have the user's information to hand and will respond appropriately, e.g. contacting a family member or neighbour or calling the emergency services.

Tunstall's new Device Management Platform (DMP) has been introduced to provide flexible cloud-based management of Smart Hub units, allowing their firmware and configuration settings to be updated remotely. DMP is completely separate from the call handling platform, so plays no role in telecare alarm handling nor does it hold records relating to Smart Hub users.

With digital (IP) connectivity and benefitting from Tunstall's DMP, the Lifeline Smart Hub provides a ground-breaking, future-proof foundation for the delivery of Connected Care.

### 1.2.1 Smart Hub communication methods

#### Monitoring centre and Smart Hub

A Smart Hub has three methods of connection to the monitoring centre, so that an alternative method may be used if one of the others are unavailable. It can communicate:

1. Across a cellular data network to access the internet for communication of data

2. Using an Ethernet/fixed broadband line to access the internet for communication of data, including Voice over Internet Protocol (VoIP)
3. Across a cellular network for voiceband, that is, voice, ‘tones’ and SMS communication

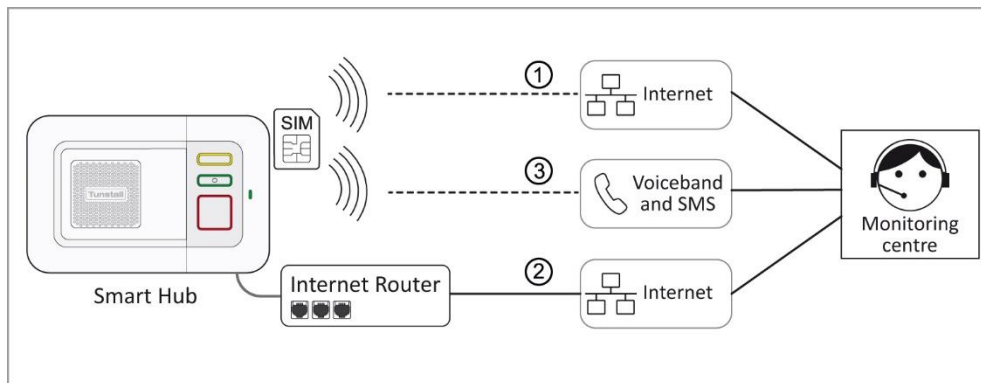

Communication over cellular connection paths (1 & 3) uses a network accessed by the SIM card. They are used to transmit both data, such as alarm information, and voice calls between the Smart Hub and monitoring centre. In some instances, path 3 can also be used to transmit the alarm call data in the form of an SMS message. Typically, devices can ‘roam’ between networks thus maximising coverage and availability. For data transmissions, this method of connection is like accessing the internet on a smart phone network (whilst not connected to Wi-Fi), and when a voiceband call is made, it is like making a mobile phone call.

An Ethernet/fixed broadband line (2) directly connects the internet to the device, via the user’s own domestic or other local broadband router. This can be used to transmit both IP data, such as alarm calls, and VoIP calls between the operator and the Smart Hub user. This method of connection is similar to using any other device to access the internet via a fixed broadband line.

**Note: Domestic broadband connections can be unreliable, especially in the case of a mains power failure to the router/modem. However, cellular services usually remain available, providing the device is within the coverage area of an accessible network. Because of this, Tunstall recommends that you do not rely solely on a domestic Ethernet/fixed broadband connection.**

### DMP and Smart Hub

A Smart Hub has two methods of accessing the internet for connection to DMP. It can communicate:

- a. Across a cellular data network
- b. Using an Ethernet/fixed broadband line

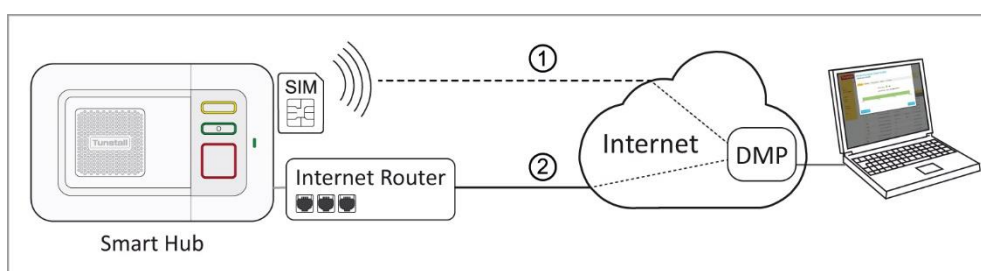

The connection is used to transmit data such as heartbeats, firmware and configuration updates between DMP and the Smart Hub.

## 1.3 Typographical conventions

- Names of fields, buttons, etc. are shown in **bold**.
- References, including those to external documents, are shown in *italics*.
- Links to other sections of the document are shown in teal.
- Warnings are indicated by the  icon and have rule lines both above and below their text.
- Notes will be indicated by:

**Notes: With the information requiring extra attention held inside the highlighted box.**

## 1.4 Related documents

Part No.	Title
D5727002A	Lifeline Smart Hub™ User Guide - Australia
D5727004A	Lifeline Smart Hub™ Short Guide – Germany
D5727005B	Lifeline Smart Hub™ User Guide - Germany
D5727006A	Lifeline Smart Hub™ User Guide – UK
D5727008A	Lifeline Smart Hub™ User Guide – Europe-wide
D5727017A	Lifeline 4G Smart Hub™ User Guide – Europe-wide
D5727051F	Device Management Platform Reference Guide
D5747001A	Lifeline 4G Smart Hub™ User Guide – UK

## 2 What's in the Smart Hub box

Each Smart Hub box contains:

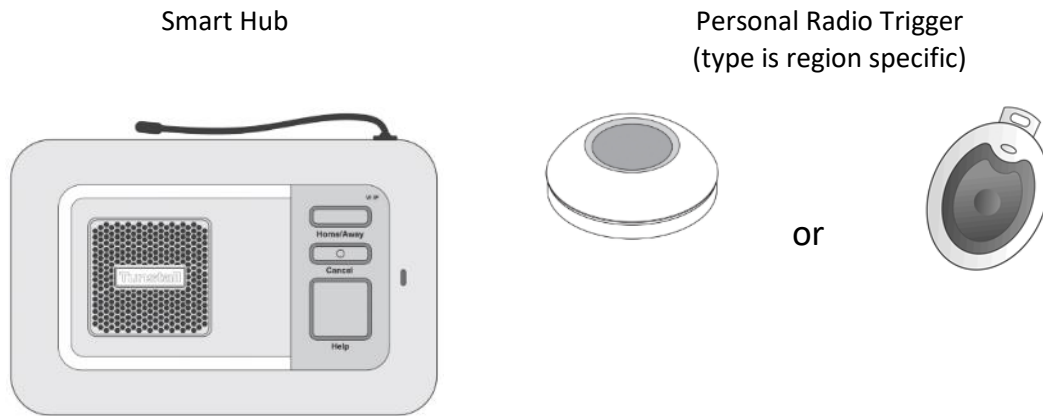

Together with:

- wrist strap and neck cord, to attach the Personal Radio Trigger
- mains power adaptor, with a three-metre cable
- user guide, which should be kept with the unit.

**Note: If any of the above is missing, please contact your supplier.**

The Smart Hub comes with a pre-fitted SIM card, enabling immediate access to the Tunstall Connectivity communication service.

Optional Extras:

3G External Antenna (S2205017)

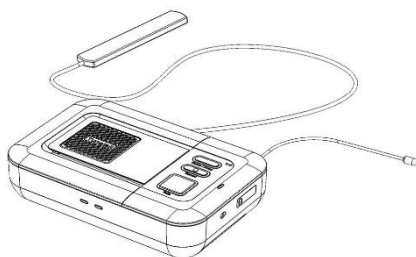

Pattress (D5702920)



Table Stand (D5702904)

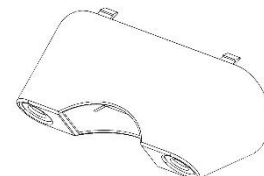



## 2.1 The Smart Hub

### 2.1.1 Front/top view

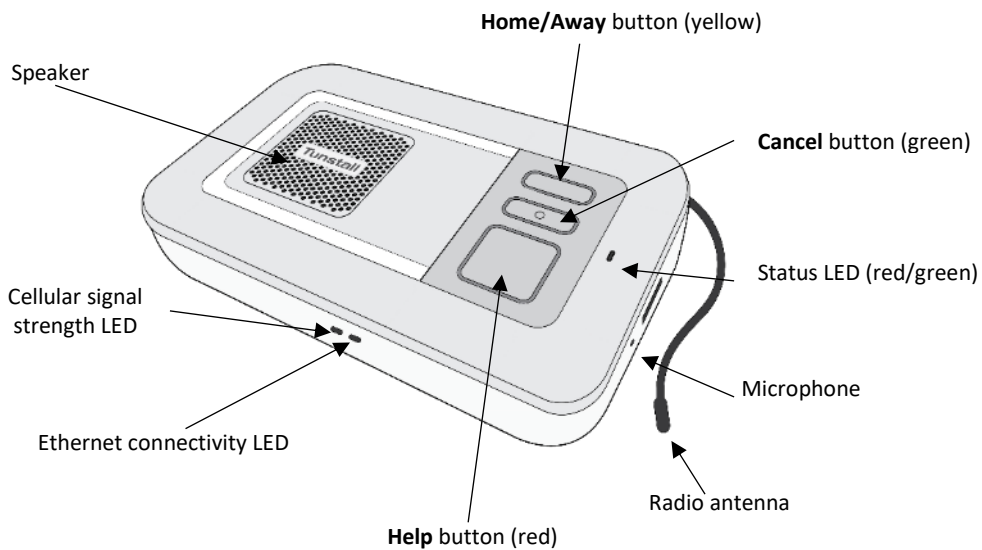

### 2.1.2 Rear view

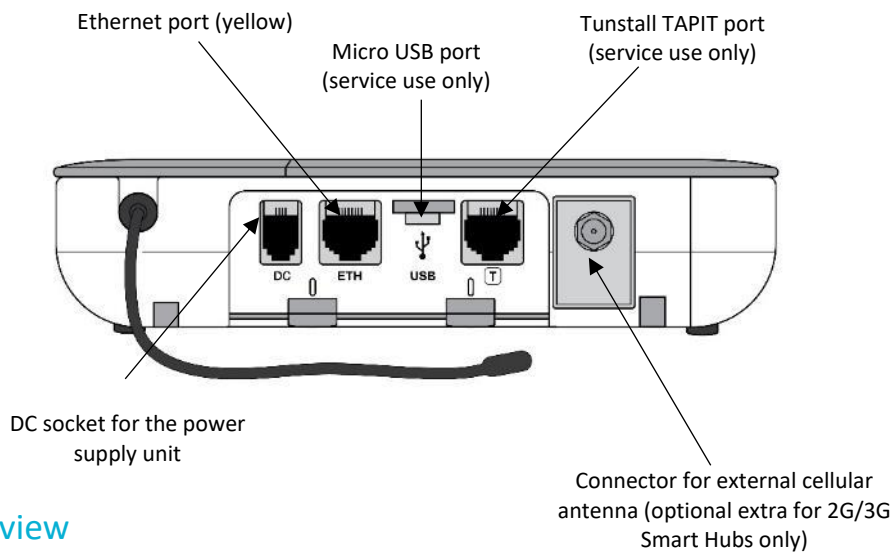

### 2.1.3 Base view

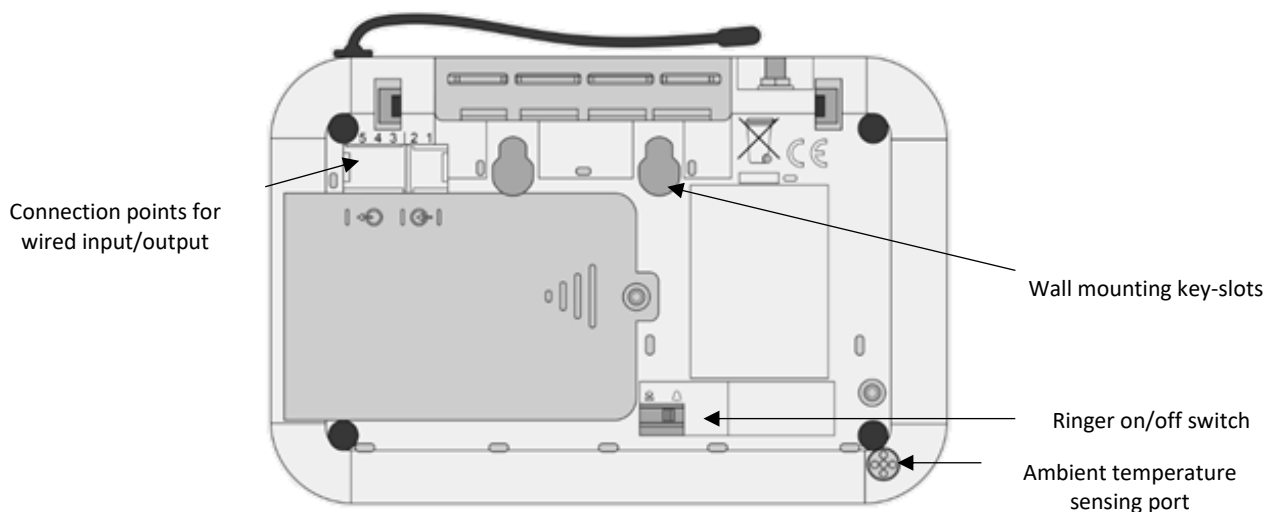

## 2.2 Warning/status lights on the Smart Hub

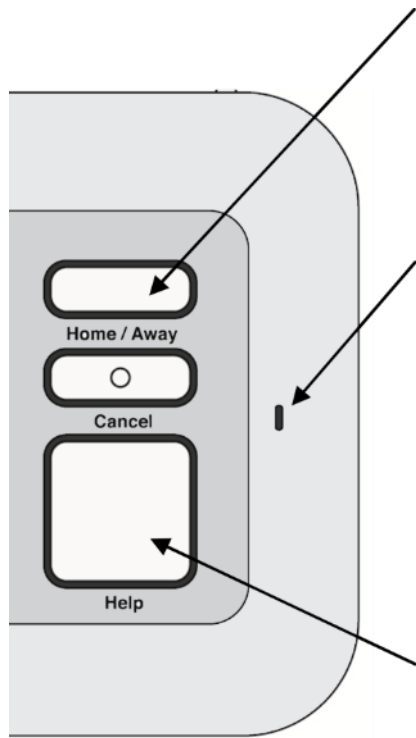

Home/Away button (yellow)	Smart Hub status
On	Away mode
Off	Home mode

Status LED (green/red)	Smart Hub status
Green LED on	Normal mode
Red LED flashing (one every four seconds)	Low internal battery
Red LED flashing (one every second)	No external communications (4G units may routinely indicate a slow flashing red when operating on battery)
Red/Green LED alternate	Reduction in radio coverage
Yellow LED flashing	Configuration/software update in progress

Help button(red)	Smart Hub status
On	Normal mode
Flashing (one every four seconds)	Normal mode running on battery When operating on battery power any other active status indication will also flash
Flashing (one every second)	Alarm mode or Programming mode
Flashing (two every second)	Registration mode

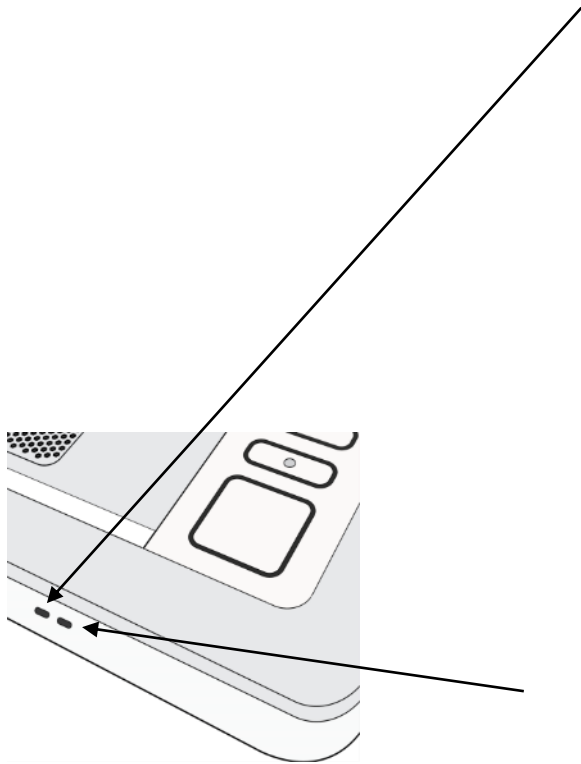

### Cellular Network Signal Strength status

The indicated presence of a cellular signal relates to the ability to connect to a network and support a voice/tone connection. There may be situations (usually temporary) when a network connection exists but a data connection is not available.



(Dark) Green	Strong signal
Yellow/Light – Green	Good signal
Orange – Red	Poor signal
White	No SIM or network connection
Flashing White	Incorrect SIM PIN

### Ethernet status

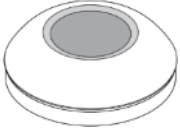

Green	Connected to the router and has internet access
Orange – Red	Connected to powered router but no internet access available
Off	Not connected to the router or router not powered

## 2.3 Personal radio trigger

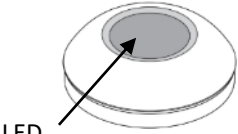
### TX4 Pendant

Wearing Options	Wrist Strap	Neck Cord
		
<p>When pressed, the red LED on the pendant:</p> <ul style="list-style-type: none"> <li>• lights up to indicate activation</li> <li>• flashes to indicate that its battery is low</li> <li>• turns green to indicate the Smart Hub has received the signal from the pendant.</li> </ul>		

### MyAmie Pendant

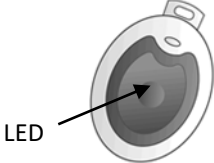
Wearing Options	Wrist Strap	Neck Cord
		
<p>When pressed, the red LED on the pendant:</p> <ul style="list-style-type: none"> <li>• lights up to indicate activation</li> <li>• flashes to indicate that its battery is low.</li> </ul>		

## 3 Installing the Smart Hub

Before installation, the Smart Hub must be prepared for active use, including:

- Within DMP:
  - moving the device from virtual district 'Customer Stock' into the appropriate active district
  - defining the aspects of the unit's configuration, typically with the use of templates
  - downloading the defined configuration attributes from DMP to the unit and then installing them, or ensuring they are ready to download and install when the unit powers up and connects to DMP.
- At the destination monitoring centre system:
  - setting up a record for the Smart Hub, typically including property and user details.

As you go through the installation, you may hear the Smart Hub make several announcements. For an explanation of these, please refer to Appendix B, [Smart Hub announcements](#).

### General installation advice

#### Do:

- follow the information contained within this guide
- fully test the installation before making the Smart Hub unit operational
- follow the shut-down process, if you need to disconnect and switch off a Smart Hub.

#### Do not:

- expose the Smart Hub to water or other liquids
- connect cables other than those stated in this guide.

### 3.1 Stage 1 – Determine the location of the Smart Hub

Locate the unit in an area that:

- provides good audio coverage for the user
- is not close to sources of heat, noise or electrical interference, such as televisions, radios, washing machines, microwave ovens, personal computers etc.
- is within safe cable reach of a mains socket
- is likely to provide good cellular signal availability
- if required, is within safe cable reach of the user's internet router.

The unit should be placed in the location and position it will remain during operation. However, it should not be permanently fixed at this point in the installation process as it may need to be moved at a later stage, e.g., if cellular signal is insufficient.

## 3.2 Stage 2 – Connect leads and power up the Smart Hub

### 3.2.1 Connect the optional Ethernet cable

This is required only if there is a fixed line broadband connection. To connect the optional Ethernet cable:

1. Insert an Ethernet cable into the yellow port on the rear of the Smart Hub labelled 'ETH'. Use a good quality CAT5 or better cable of a suitable length.
2. Connect the other end of the Ethernet cable to the user's internet router, ensuring it is safely routed so as not to present any hazards.

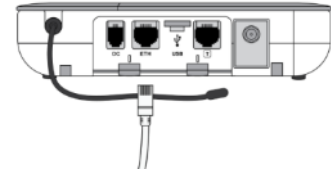

### 3.2.2 Connect the mains power adaptor



Only use the power adaptor supplied with the unit and ensure all preceding steps are complete, including the Ethernet/fixed broadband service connections, as required.

To connect the mains power adaptor and power up:

1. Plug the mains adaptor into the Smart Hub socket labelled 'DC'.
2. Connect the adaptor to the mains power.
3. The Smart Hub starts to power up, with the status LEDs on the top and front of the Smart Hub changing to indicate progress. See Section 2.2, [Warning/status lights on the Smart Hub](#), for the indications on the Smart Hub relating to cellular and internet service. As the unit powers up, it may make several announcements, as listed in Appendix B, [Smart Hub announcements](#).

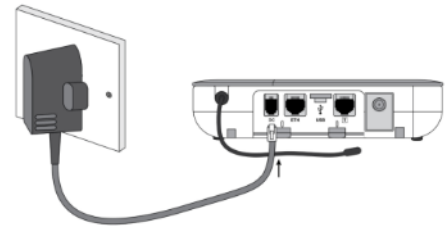

The Smart Hub will test each available cellular network and then select the best service at the location. During the "scan" process the cellular status LED may intermittently show white.

4. On completion of power up and cellular scan/registration, the unit attempts to connect to DMP. It may take up to 6 minutes to reach this point but is often much quicker.
5. Once connected, the Smart Hub may download updated configurations or operating firmware, as indicated by the announcements it makes. In addition, if the operating firmware is updated, the Smart Hub may make alarm calls. These are memorised calls which previously failed to connect and were not removed by pressing the **Cancel** button.
6. If there is no Ethernet connection and the cellular signal strength is insufficient, connection is not possible. In this case, check the possible communication channels:
  - For the cellular service, check that the connection status that appears on the device's Cellular service tab within DMP is either "Activation Ready" or "Activated", as described in the *Device Management Platform Reference Guide*.
  - For the broadband connection, check the cabling is correctly fitted, the router is working, and the service is enabled.
7. Once connection has been established:
  - If the Smart Hub is new and has not been previously installed, go to Stage 4 to confirm the cellular signal strength. This is because it will be configured automatically to use its

- If the Smart Hub has been previously installed or you are unsure whether it is configured to use the internal antenna, go on to the next stage to check use of this antenna.

### 3.3 Stage 3 – Check use of the internal antenna

You implement the internal antenna as follows:

1. Press and hold the yellow **Home/Away** button for 10 seconds.
2. If the unit announces:
  - "Internal antenna selected", the unit has switched to using the internal antenna
  - "External antenna selected", repeat step 1 to return to using the internal antenna
  - "Please wait", the unit is unable to process the request immediately, e.g. if an alarm call is currently raised. Once the Smart Hub can process the request, it makes the appropriate announcement which you action as required.
3. Once the unit is using the internal antenna, go on to the next to stage to confirm cellular signal strength.

### 3.4 Stage 4 – Confirm the cellular signal strength

To confirm the cellular signal strength:

1. Ensure that the LED status indicator on the unit is normal, as described in Section 2.2, [Warning/status lights on the Smart Hub](#).
2. Ensure the red **Help** button is in normal mode, as described in Section 2.2, [Warning/status lights on the Smart Hub](#). If an alarm is in progress, i.e. the unit is in alarm mode, deal with the alarm before continuing with the test.
3. Test the cellular signal strength, as follows:
  - i) Note the colour of the LED status indicator on the Smart Hub.
  - ii) Press and hold the yellow **Home/Away** button for 6 seconds.

The Smart Hub announces the cellular signal strength as a value from 0 (No signal) to 31 (Strong signal) every ten seconds for a period of five minutes. To cancel these announcements, press the green **Cancel** button.

4. Use the results of the tests to determine the overall cellular signal strength from the table below.

Smart Hub Announcement	Smart Hub LED Colour	Overall Signal Strength
0	White	No signal – connection not made
1 to 6	Orange – Red	Poor signal – may not provide consistent service
7 to 9	Yellow – Light Green	Acceptable signal
10 to 18	Yellow – Light Green	Good signal
19 to 31	Dark Green	Strong signal

**Note:** Tunstall strongly recommends that you only consider ‘Acceptable’, ‘Good’ or ‘Strong’ cellular signal strengths to be capable enough to provide monitoring.

5. If using the internal antenna and the cellular signal strength is insufficient:
  - a. Repeat this test in differing locations within the property. Ensure you allow sufficient time, for the LED status indicators to show the change in signal with each move (at least 30 seconds). Once you find a suitable location, no further cellular strength testing is required.
 

**Tip:** You may find it more convenient to disconnect the mains power/Ethernet cables from the unit for these tests, reconnecting them at the end of this step. However, in this case the LED status indicators will take up to two minutes to update.
  - b. If you cannot find a suitable location, for 2G/3G Smart Hubs, complete stage 5 to set up the external antenna and repeat this test to check changes to the cellular signal strength. For 4G Smart Hubs, go to stage 6b.
6. If using the external antenna and the cellular signal strength is insufficient:
  - a. Repeat this test with the antenna in differing locations within the property. This may require you to move both the unit and antenna. Ensure you allow sufficient time for the LED status indicators to show the change in signal with each move (at least 30 seconds). Once you find a suitable location, no further cellular signal strength testing is required.
 

**Tip:** You may find more convenient to disconnect the mains power/Ethernet cables from the unit for these tests, reconnecting them at the end of this step. However, in this case the LED status indicators will take up to two minutes to update.
  - b. If no suitable location can be found, contact your supervisor for further instructions.
7. Once you have a location with suitable cellular strength for the unit:
  - go to stage 6, if you have one or more personal triggers or telecare sensors to register
  - go to stage 7, if you have no additional triggers/sensors to register, to test the range of the personal trigger supplied with the Smart Hub.

### 3.5 Stage 5 – Set up the external cellular antenna

Connecting an *optional* external cellular antenna of the correct type to a 2G/3G Smart Hub will increase the unit’s signal announcement values by two or three, with three representing more than double the original signal strength. In addition, the external antenna gives greater flexibility to be located in an area with a good signal.

**Note:** It is very important to use the correct external antenna. Use S2205017 for original (2G/3G) Smart Hubs.

**Note:** The unit’s signal level announcements do not increase proportionally to actual signal strength – a small increase in spoken signal level still represents a significant increase.

To connect the external cellular antenna:

- Connect the antenna to the antenna socket on the rear of the Smart Hub.
- Temporarily fix the body of the antenna vertically. This should be:

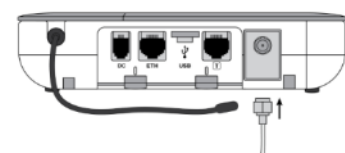



- At least 0.5m from the Smart Hub
- on a non-metallic surface
- in an area expected to have a good signal, such as near a window
- indoors as the antenna is not waterproof.

Once connected, implement the external antenna as follows:

1. Press and hold the yellow **Home/Away** button for 10 seconds.
2. If the unit announces:
  - "External antenna selected", the unit has successfully switched to using the external antenna
  - "Internal antenna selected", repeat step 1 to return to using the external antenna
  - "Please wait", the unit is unable to process the request immediately, e.g. an alarm call is currently raised. Once the Smart Hub can process the request, it makes the appropriate announcement which you action as required.

**Note: If the Smart Hub did not connect to DMP in a previous installation stage but can now make a connection, the unit may download updated configurations or operating firmware, as described in that stage.**

3. Once connection has been established, return to Stage 4 to confirm cellular signal strength.

### 3.6 Stage 6 – Prepare sensors for use as the virtual property exit sensor

**Note: Omit this stage if the client does not require a virtual property exit sensor.**

To prepare the sensors required for use as the virtual property exit sensor:

1. Ensure that a Universal Sensor is installed on the required door(s) and is set to door open/door close mode.
2. Ensure that one or more Fast PIRs (Passive Infrared sensor), are installed to the side of each doorway to be monitored, covering the approach to the door but not the final inch of the door closing action. (This avoids false activity being detected after door closure, as the Universal Sensor registers closure when the door is close to the door frame, not when it actually closes.)

### 3.7 Stage 7 – Register personal triggers/telecare sensors

Next, you locally register any personal trigger or telecare sensor with 'plug and play' functionality. The only exception is the personal trigger supplied with the Smart Hub, as this is already registered.

To locally register the 'plug and play' triggers/sensors:

1. Press and hold down the green **Cancel** button as shown below.

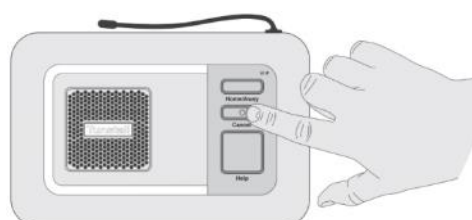

2. When the Smart Hub bleeps (after approximately five seconds), release the green **Cancel** button. The Smart Hub announces, 'Programming mode', and the red **Help** button flashes slowly.
3. Press and hold down the green **Cancel** button.
4. When the Smart Hub bleeps (after approximately three seconds), release the green **Cancel** button. The Smart Hub announces, 'Registration Mode,' and the red **Help** button flashes rapidly.
5. Activate the trigger/sensor. The Smart Hub makes an announcement confirming the registration.
6. Register any remaining triggers/sensors by repeating step 3 onwards. If you leave more than 2 minutes between registrations, repeat the process from step 1 as the Smart Hub will have reverted to normal operating mode.
7. Press the green **Cancel** button to revert to normal operating mode.
8. Press the green **Cancel** button to initiate a DMP connection. Typically, within a few seconds though it can take up to a minute, the unit announces:
  - "Connected to DMP" if it can connect to DMP
  - "Connection attempt to DMP failed" if it cannot connect to DMP

Once connected, the Smart Hub uploads the trigger/sensor details, as indicated by the announcements it makes. Appendix B, [Smart Hub announcements](#), provides details of the spoken announcements which may be heard during this this step.

Once you have registered the triggers/sensors, go on to the next stage to test their range.

### 3.8 Stage 7 – Test the range of personal triggers/telecare sensors

You need to test the range of the personal trigger supplied with the Smart Hub and any trigger/sensor you registered in the previous stage.

To test the range of the triggers/sensors:

1. Press and hold down the green **Cancel** button.
2. When the Smart Hub bleeps (after approximately five seconds), release the green **Cancel** button. The Smart Hub announces, 'Programming mode', and the red **Help** button flashes slowly.
3. Activate a trigger/sensor. The Smart Hub announces the trigger/sensor type and beeps to confirm that it is within range. The announcement is at the highest possible volume, but you can adjust this when configuring the unit as described in Section 4.3, [Stage 3 – Configure speech message settings](#).
4. If the trigger/sensor is portable, then to check coverage, repeat step 3 with the trigger/sensor at different locations within the property.
5. Repeat steps 3 and 4 for each trigger/sensor. If you leave more than 2 minutes between tests, repeat the process from step 1 as the Smart Hub will have reverted to normal operating mode. As a warning, the unit emits "pip" tones towards the end of this 2-minute interval.

Once you have tested the range of the triggers/sensors:

- if you need to connect any hardwired devices, complete stage 8.

- if you need to fix the Smart Hub permanently in position, including its external antenna, or are using a table stand, complete stage 9.

If neither stage is required, then installation is complete. Please proceed to configure the Smart Hub unit, as described in Section 4, [Configuring the Smart Hub](#).

## 3.9 Stage 8 – Connect hardwired devices

The steps required to connect input and output hardwired devices differ slightly, so are described separately below.

Once you have connected any required hardwired device, then:

- If you need to fix the Smart Hub permanently in position, including its external antenna, or are using a table stand, complete stage 9.
- If stage 9 is not required then installation is complete, and you go on to configure the Smart Hub unit as described in Section 4, [Configuring the Smart Hub](#).

### 3.9.1 Connect a hardwired input device

To connect a hardwired input device:

1. Check the trigger/sensor provides a voltage-free normally-open or normally-closed contact output.
2. Locate the hardwired input connections on the underside of the unit within a green terminal block, that is, positions 1 and 2.
3. Connect the pair of wires to positions 1 and 2 as follows:
  - a. Using a narrow-bladed screwdriver, depress the orange spring-clamp contact control lever.
  - b. Place the wire in position 1 or 2 of the block, as required.
  - c. Release the lever.
4. Secure the cable appropriately to protect against strain and accidental disconnection.

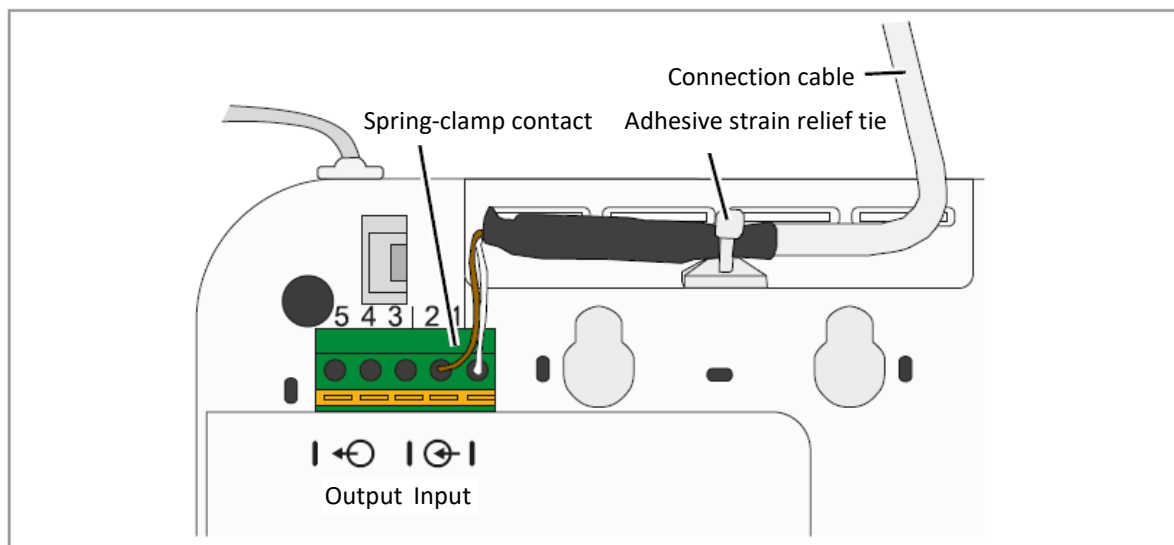

### 3.9.2 Connect a hardwired output device

To connect a hardwired output device:

1. Check the device is suitable for control by a voltage-free relay contact rated at 1A-30Vdc or 300mA-125Vac.
2. Locate the hardwired input connections on the underside of the unit within the green terminal block, that is, positions 3, 4 and 5.

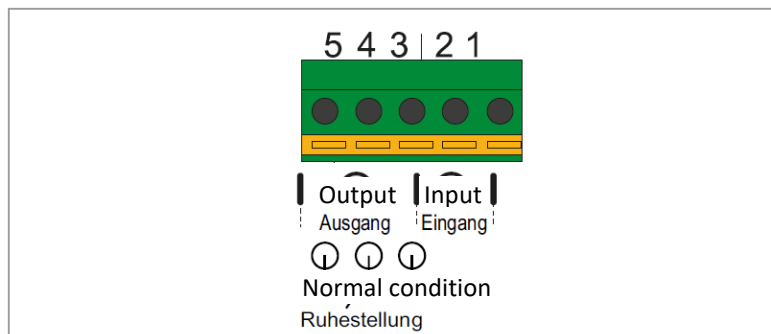

3. Connect the pair of wires to positions 3 and 4, if the contacts are normally open, and positions 4 and 5, if normally closed, as follows:
  - a. Using a narrow-bladed screwdriver, depress the orange spring-clamp contact control lever.
  - b. Place the wire in position 3, 4 or 5 of the block, as required.
  - c. Release the lever.
4. Secure the cable appropriately to protect against strain and accidental disconnection.

## 3.10 Stage 9 – Fit the Smart Hub in the required location

This section describes how to fit the Smart Hub if it:

- requires an external antenna, or,
- is to be mounted on a wall, or,
- uses the table stand.

If the Smart Hub is to be wall mounted, you can either use the optional Tunstall pattress or fit the unit directly to a wall using the key-slots moulded into the rear of the case. If the Smart Hub is to be placed on a horizontal surface, you can fit it with the optional Tunstall table stand which tilts the unit at an angle and allows for tidy cabling.

**Note:** Before fitting the Smart Hub in the required location, ensure you take note of its product code (PRC) as it will be inaccessible once the unit is fitted. You use the PRC to identify the unit when configuring it within DMP.

Once you have permanently fitted the Smart Hub, you go on to configure the Smart Hub unit, as described in Section 4, [Configuring the Smart Hub](#).

### 3.10.1 External antenna

Fix the antenna permanently using its self-adhesive strip.

### 3.10.2 Wall mounting with pattress

Tunstall can supply an optional pattress (part number D5702902C) which conceals the cable connections to the unit and allows the unit to be mounted directly to the wall, or onto a recessed electrical back-box. If a unit with an Ethernet connection is to be wall mounted with the pattress, then, prior to installation, ensure that the Ethernet cable and connector fit under the cover.



Use with metal back-boxes is not recommended due to potential radio frequency shielding effects.

To mount the Smart Hub on a wall using the pattress:

1. Disconnect the cables from the Smart Hub. Place the pattress in the correct horizontal position on the wall. If the connecting cables are concealed in the wall, feed them through the larger central hole (image 1).



2. Use the screw holes/slots to fix the pattress to the wall, choosing appropriate fixings for the type of wall. The holes/slots enable fitting to standard electrical back-boxes.
3. Remove the two rubber feet from both front/lower corners of the Smart Hub (image 2a) and store them in the slots provided in the pattress (image 2b).

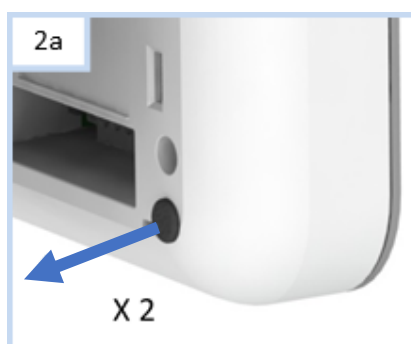

4. Re-connect the cables to the unit, as described in previous stages.

- Clip the Smart Hub onto the wall pattress, ensuring any cables correctly feed through the pattress back or slot, as required. Images 3a and 3b show how to locate and clip the Smart Hub to the pattress.

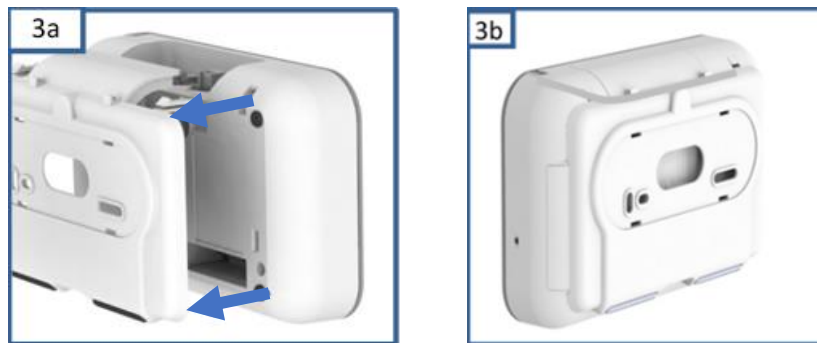

### 3.10.3 Wall mounting without pattress

To mount the Smart Hub on a wall without using a pattress:

- Place the unit in the correct horizontal position on the wall and use the two wall mount markers to accurately mark the wall, as shown below. The diagram is not drawn to scale so should not be used for measuring purposes.

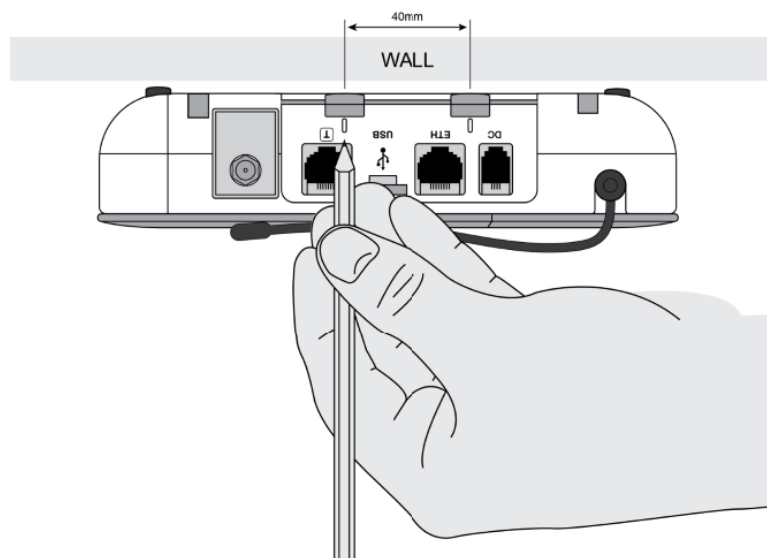

- Drill 2 holes 40 mm apart, on the marks you made in the previous step.
- Firmly attach suitable screws for the wall type, leaving the screw heads protruding from the surface.
- Place the wall mounting points on the back of Smart Hub over the screws. Lower the unit to lock the screw heads into the key-hole slots.
- Check that the unit is held securely. If necessary, remove, adjust the screw length and repeat step 4.

### 3.10.4 Fitting the table stand

Tunstall is able to provide an optional table stand (part number D5702904C) which allows the buttons and speaker to be angled towards the user instead of lying flat on a surface. This also covers where cables connect to the unit, helping to prevent cables from being unplugged.

The stand is formed from two parts, a wall pattress (2) and an additional clip-on foot (3).

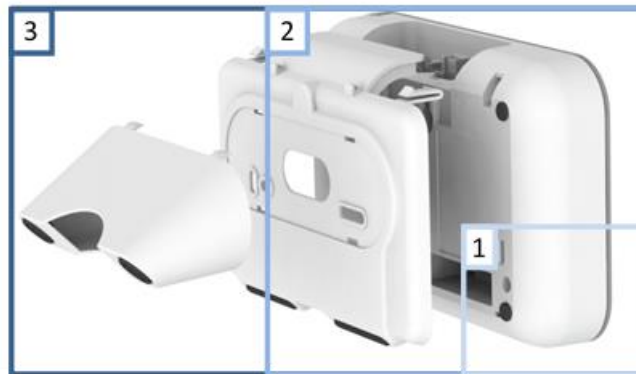

To fit the table stand:

1. Remove the two rubber feet from both front/lower corners of the Smart Hub (image 1a). These can be stored in the slots provided in the pattress (image 1b).

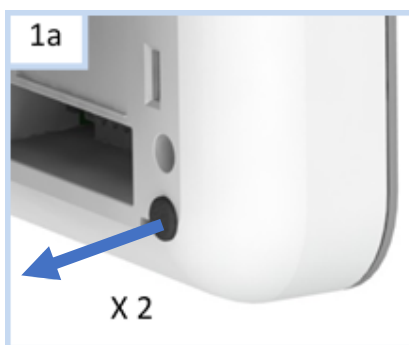

2. Clip the foot to the wall pattress, ensuring the foot is angled down (image 2).

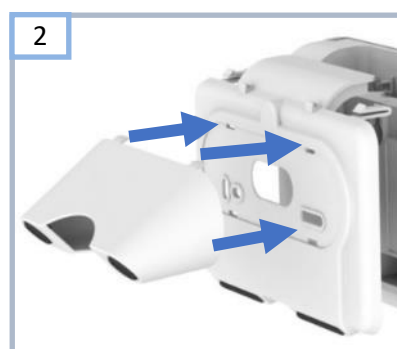

3. Feed the cables through the base of the foot and the large hole in the pattress (image 3). Connect the cables to the Smart Hub's sockets.

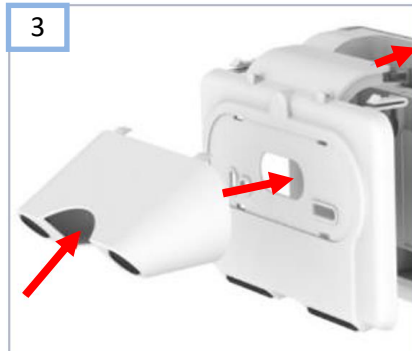

4. Fit the table stand assembly to the Smart Hub whilst adjusting cables and feeding them back/down as necessary. Image 4 shows how to locate and clip the assembly to the Smart Hub but for clarity shows it without the cabling/foot.

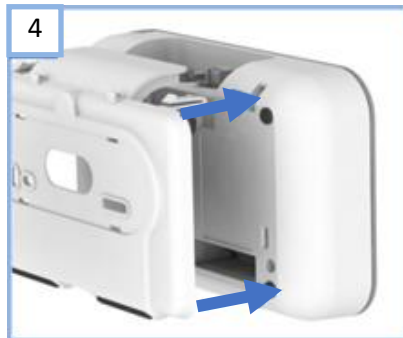

5. Ensure that the completed assembly sits with the foot flat on a surface as shown in image 5, with all the cables passing out of the foot indicated by the red arrow.





## 4 Configuring the Smart Hub

This chapter describes how to configure the Smart Hub unit using DMP.

To configure the Smart Hub unit installed in the previous chapter, you require:

- DMP username and password, with “Customer Advanced” permission level access to the appropriate DMP district
- The device to be located in the required DMP district
- The list of configuration attributes to be amended, together with their required values, typically provided by your supervisor. These values should be in line with your organisation’s policies, and, if relevant, their customer’s policies. The only attributes that you should change without such values are those relating to the user’s personal requirements.
- If your organisation enforces two-factor verification, you also require the tokens from Google Authenticator and need to apply them at appropriate points in the configuration process. For clarity, the procedure described in this chapter does not include any references to two-factor verification. For details of this feature, refer to the *Device Management Platform Reference Guide*.

Tunstall strongly recommends that as much of the configuration as possible is carried out prior to installation, however it is not possible to finalise it. As a minimum you need to change those settings that relate to the user’s personal requirements e.g., the ringing volume of the unit.

This chapter covers each setting that might require configuration in a typical installation. Please go through all the stages of this chapter in the order they are presented, omitting those relating to the settings that are pre-configured for the Smart Hub you are currently installing. The configuration process is split as follows:

- Stages 1-5 relate to configuring the Smart Hub so that it can work in the appropriate time zone, connect to communication channels, work with DMP, and make announcements in the appropriate language.
- Stages 6-17 relate to the telecare and alarm operational features necessary for the Smart Hub to operate in accordance with the service provider’s policies and the user’s requirements.

**Note:** For detailed descriptions of the DMP screens, the significance of the fields within them and how their settings impact the Smart Hub, refer to the *Device Management Platform Reference Guide*.

As you make changes to the unit’s configuration, DMP outlines each updated field in red.

These changes transfer from DMP to the Smart Hub whenever the Smart Hub next connects to DMP, either at the regular interval (“heartbeat”) or when prompted by pressing the green **Cancel** button.

As an alternative to manually specifying all the settings, you may configure some of them by applying a template, if this has not been done prior to installation. For details on how to do this, refer to Appendix D, [Applying a template to a device](#).

## 4.1 Stage 1 – Log on to DMP and access the configuration settings

To log on to DMP and access the configuration settings:

1. Use a recent version of any internet browser, but preferably Chrome, to access DMP's web address. DMP is located at:

- Australia: <https://dmp-au.tunstall.com>
- China: <https://dmp-cn.tunstall.com>
- Europe: <https://dmp-eu.tunstall.com>

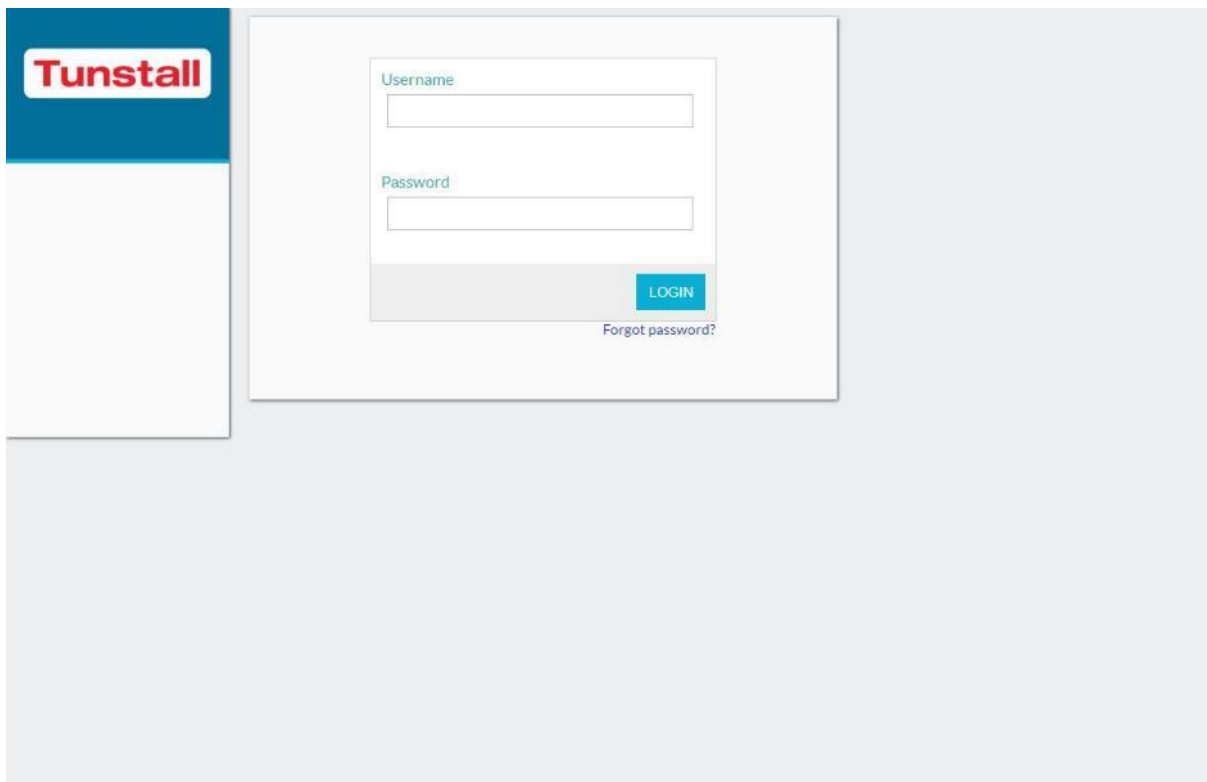

2. Enter your username and password to display your Start page, which is similar to the following:

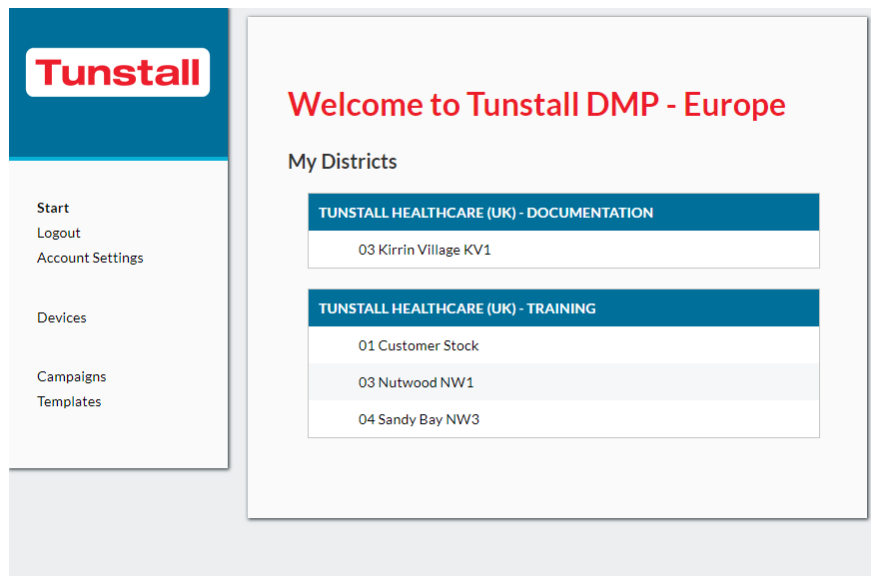

3. Select the **Devices** menu option, to display the View Devices List page.

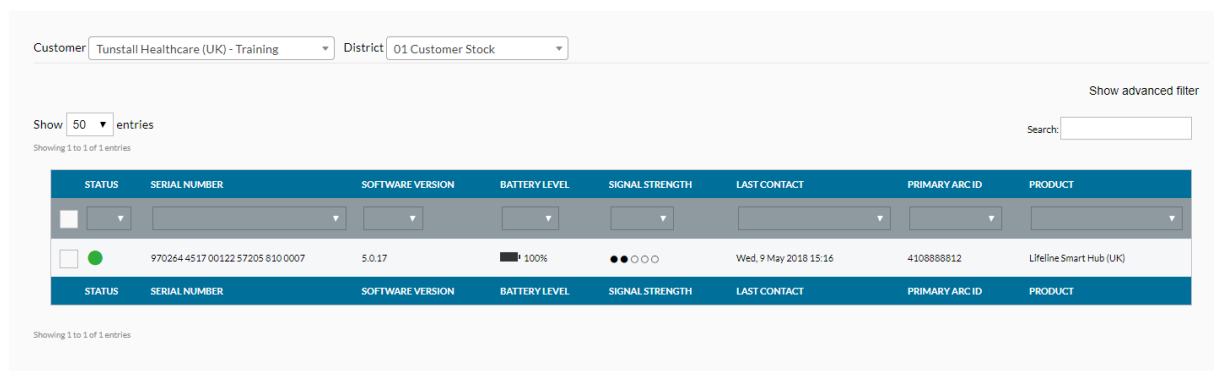

4. If you have access to multiple customers and/or districts, select the customer and district containing the device to be configured using the **Customer** and/or **District** drop-down lists.
5. Use any of the standard list options to display the Smart Hub's details. Alternatively, click **Show advanced filter** and then enter all or part of the 27-digit product code (PRC). Ensure that there is a complete match between the product code listed on the Smart Hub's label and the contents of DMP's **SERIAL NUMBER** field.
6. Select the Smart Hub by clicking on any of its details. DMP displays the Device Information window, as shown below:

970264 4517 00123 57205 810 0006  
Vi-IP 869

- Overview**
- Heartbeats
- Event log
- Cellular service
- Preferences

Current status ● OK

Last contact **Thu, 26 Jul 2018 09:06**



SETTINGS

CLOSE

- Click the **SETTINGS** button to open the Device Settings page. This selects the **Ringing** menu option by default.

970264 4517 00123 57205 810 0006

- Ringling**
- Speech
- Smart Hub Settings
- Event
- Sensor
- Calls
- IP Interface
- Mains Monitoring
- Cellular
- Inactivity Monitoring
- Integral Ambient Temper
- Home Or Away Button
- Hardwired Input
- Periodic Monitoring Profi
- Periodic Monitoring Profi
- Time Window
- Virtual Property Exit Sen

### Ringling

Enable Audible Ringing	<input checked="" type="checkbox"/>
Final Ringing Level	10 ▾
Initial Ringing Level	1 ▾
Rings Between Level Change	1
Volume increase (dB)	1 ▾

SAVE

## 4.2 Stage 2 – Configure the time zone

To configure the time zone:

1. Within the Device Settings menu, select the **Smart Hub Settings** menu option to display:

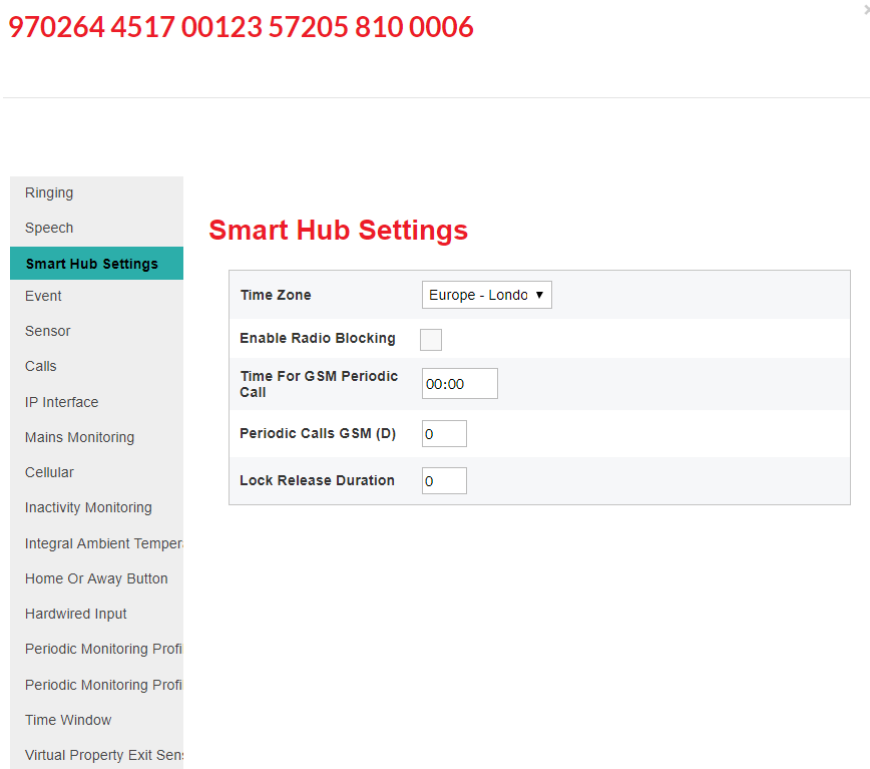

2. If required, select the correct zone from the **Time Zone** drop-down list. If a change is made, the field is outlined in red and DMP changes the **SAVE** button from grey to blue to indicate the pending unsaved changes.
3. Leave the other settings in this group at their default values at this stage.

### 4.3 Stage 3 – Configure speech message settings

To configure the speech message settings:

1. Within the Device Settings menu, select the **Speech** menu option to display:

970264 4517 00123 57205 810 0006

The screenshot shows the 'Speech' configuration page. On the left is a sidebar menu with 'Speech' highlighted. The main content area is titled 'Speech' and contains the following settings:

- Speech**
  - Language: Australian Engl
  - Default Speaker Volume: 5
  - Audio Level (Range Test): 10
- Reassurance Speech**
  - Reassurance Speech: Use Event Setti
  - Announce Prefix:
  - Announce Battery:
  - Announce Location:
  - Announce Suffix:
  - Announce Event or Type: Both
- Fault Monitoring**
  - No Fault Monitoring Speech Start Time: 22:00

2. Select the appropriate language from the **Language** drop-down list.
3. If necessary, after a discussion with the user, change the value of the **Default Speaker Volume** field which defines the volume of the unit’s announcements but not the volume of the monitoring centre operator’s voice. The user should have heard some announcements during the previous stages of installation.
4. If announcements other than alarms are to be suppressed for part of each day e.g., the user’s sleeping hours:
  - a) Specify the start and end of this time period in the **No Fault Monitoring Start Time** and **End Time** fields.
  - b) Ensure **Disable Fault Monitoring Speech Within Time Window** is ticked.

## 4.4 Stage 4 – Configure pendant signalling during an alarm call

This section describes how to indicate whether a client’s pendant can be used to communicate with the responding operator after they have raised an alarm with that pendant. This communication takes the form of audio beeps generated by pressing the pendant.

To configure use of the pendant trigger’s audio beeps in this way:

1. Within the Device Settings menu, select the **Calls** menu option to display:

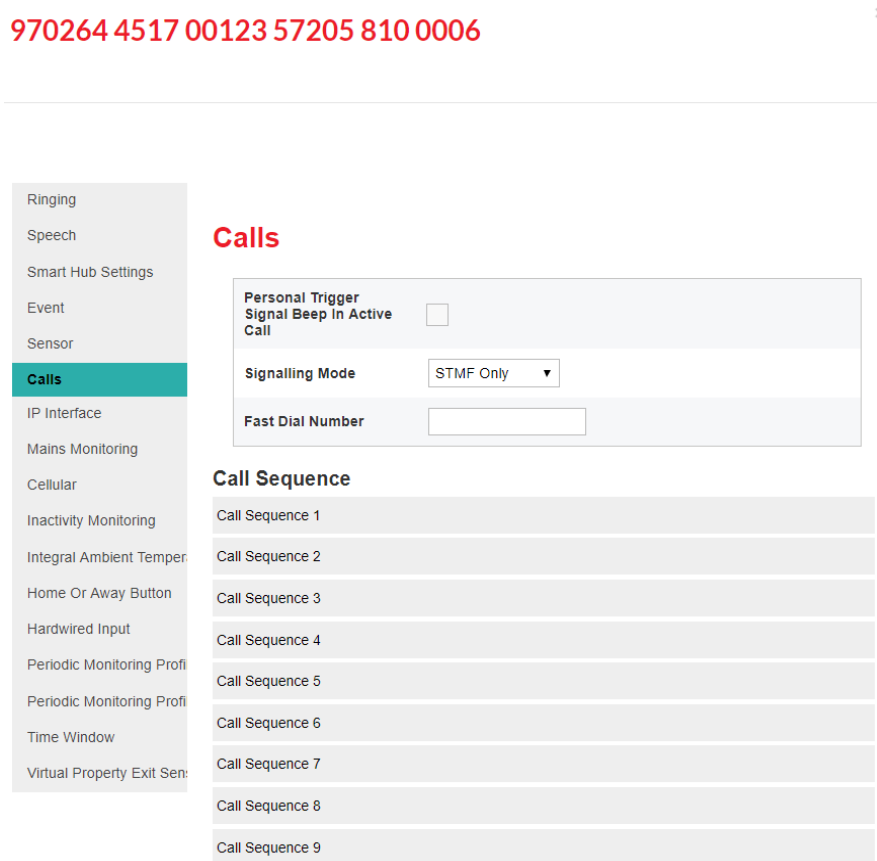

2. Ensure **Personal Trigger Signal Beep in Active Call** is ticked if the pendant may be used to communicate with the responding operator whenever that pendant triggers an alarm; otherwise ensure the field is clear.

## 4.5 Stage 5 – Configure IP data communications settings

This section describes how to configure the settings that define IP data communications between the Smart Hub and DMP. Communication may take place using either a fixed-line broadband (Ethernet Interface) or cellular/mobile networks (Cellular IP Interface); the former via a connection to the user’s home broadband and the latter using the device’s cellular connection.

To configure the IP data communications:

1. Within the Device Settings menu, select the **IP Interface** menu option to display:

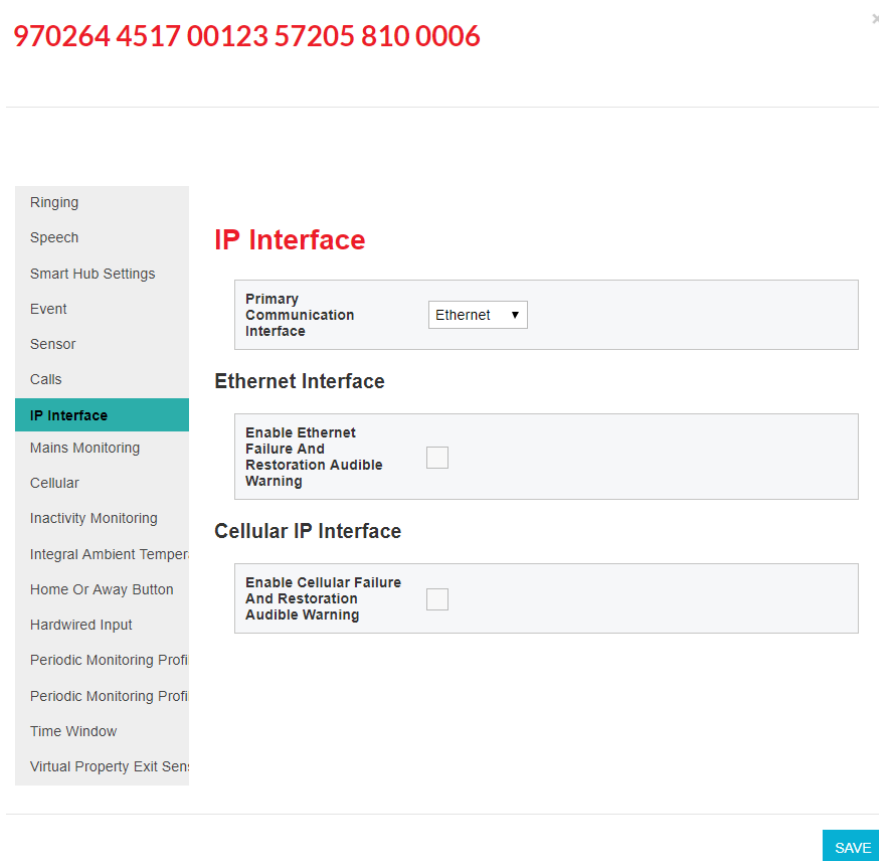

2. If both IP data communication methods are to be used, select the preferred method when both available, from the **Primary Communication Interface** drop-down list. Typically, this is “Ethernet”.



It is strongly advised that the Smart Hub is *not* installed to use only an Ethernet connection as this is usually unavailable during power failures to the user’s internet router.

3. Use the two checkboxes to indicate whether the unit is to make an announcement when the Ethernet or cellular data connection fails or is restored.



## 4.6 Stage 6 – Configure monitoring centre settings

This section describes how to configure the settings related to calls made to the monitoring centre.

Typically, the configuration of settings relating to monitoring centre call sequences and destinations will have already been applied, so it is unlikely that you need to go through this stage. However, if you do have to enter or make changes to these settings, please ensure you:

- Have a list of call sequences and associated information. This must be in accordance with your operating procedures and typically provided by your supervisor.
- Know which attributes require specifying/updating, the sequences or destinations to which they relate and the values to which they will be set.

If you require an explanation of how sequences and destinations operate to enable calls to be made correctly to the monitoring centre, refer to the *Device Management Platform Reference Guide*.

1. Within the Device Settings menu, select the **Calls** menu option to display:

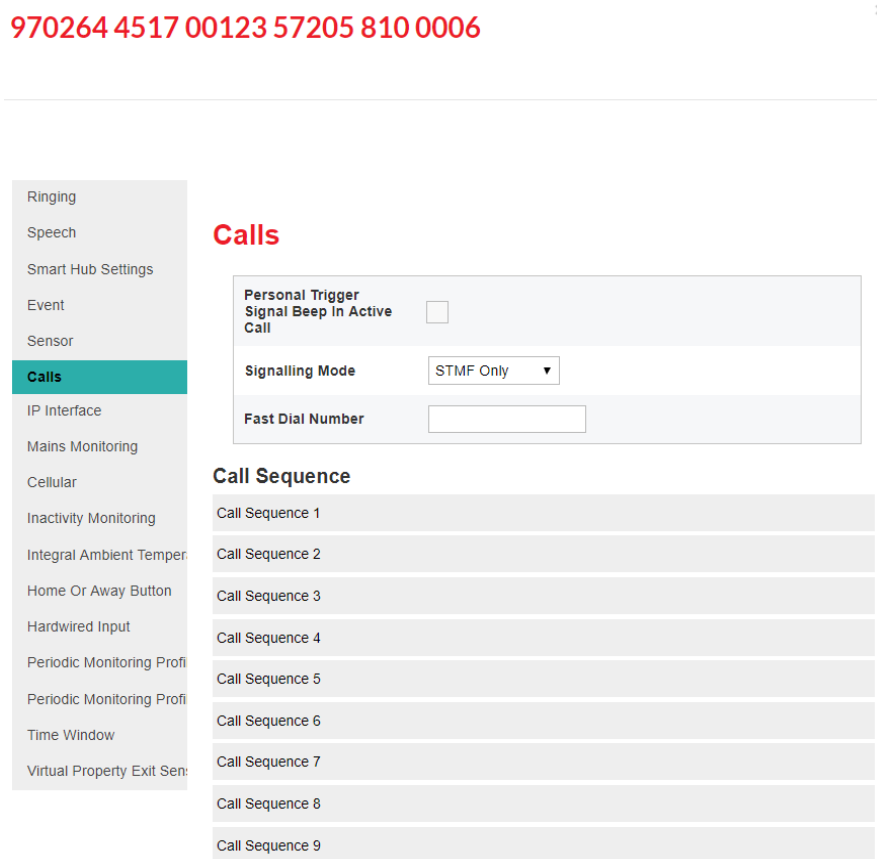

2. For each destination you need to specify or update:

- a) Select the relevant destination, by clicking the appropriate bar containing **Destination**. DMP displays the related settings.

### Destination

#### Destination 1

Unit ID	<input type="text" value="153"/>
Telephone Or IP Call	Telephone Call ▾

#### Telephone Destination

Telephone Number	<input type="text" value="01977"/>
------------------	------------------------------------

#### IP Destination

URL Or IP Address	<input type="text"/>
Supported Protocol	SCAIP ▾
ARC Port	<input type="text" value="5060"/>
SIP Connection Method	Register ▾
SIP Username	<input type="text"/>
SIP Password	<input type="text"/>
SIP Realm	<input type="text"/>
Enable SIP Authentication	<input type="checkbox"/>
Connection Type	Cellular IP ▾
Call Method	GSM Call ▾
IPACS GSM Call Method	Callback ▾
Predefined ARC Number	<input type="text"/>

- b) If not already specified, enter the **Unit ID** by which the Smart Hub being installed is known at the monitoring centre destination being configured.
- c) Ensure the **Telephone Or IP Call** drop-down list is set to:
- “IP Call”, if the destination being configured uses an IP protocol
  - “Telephone Call”, if the destination uses a tone-based signalling protocol
  - “SMS” if the destination uses Tunstall SMS protocol.
- d) In the case of an IP destination, update the required attributes as follows:
- i. Enter the destination monitoring centre’s address either as a numeric IP or a URL, for example, “123.456.789.012” or “example.domain.com”.

- ii. Select the IP alarm protocol used by the destination monitoring centre, either IPACS or SCAIP.
- iii. If required, make changes to the **ARC Port, SIP Connection Method, SIP Username, SIP Password, SIP Realm** and **Enable SIP Authentication** fields. This should have been advised by Tunstall after discussion with related parties.
- iv. Select the IP connection path to be used for the alarm call, from the **Connection Type** drop-down field, that is either “Ethernet” or “Cellular IP”.
- v. Select “VoIP Call” or “GSM Call” from the **Call Method** drop-down list, depending on the monitoring centre and chosen IP protocol. This defines how voice is to be transmitted during the alarm call.

**Note: If the chosen IP connection path is “Cellular IP”, the voice connection should be a GSM call, as cellular data services may not support stable and reliable VoIP connections. Only use VoIP if advised by Tunstall.**

- vi. For GSM calls using the IPACS protocol only, select either “Call-back” or “Dial out” from the **IPACS GSM Call Back Method** drop-down list. These options define whether the voice call is to originate from the monitoring centre or Smart Hub respectively.
- e) In the case of a telephone or SMS destination, update the required attributes as follows:
- i) Enter the destination monitoring centre’s call or SMS receiving telephone number in the **Telephone Number** field using ‘international’ format, for example, “+44...” or “0044...”.

**Note: Do not use any number which has a non-geographical code, such as “0800”.**

3. If one of the destinations has its **Telephone OR IP Call** drop-down list set to “Telephone Call”, set **Signalling Mode** to:
  - “STMF Only” if the monitoring centre supports STMF signalling, as this mode is more resilient over cellular voice band connections
  - “DTMF”, if the monitoring centre uses BS8521 only
  - “Last Successful”, if some monitoring centre equipment supports STMF and some does not. This allows the Smart Hub to switch signalling modes when necessary. However, exhausting initial attempts and switching modes may cause noticeable connection delays. You should only use this option when the destination is the last resort, should all other communication attempts fail.
4. For each call sequence you need to specify or update:
  - a. Select the call sequence to be specified or updated, by clicking the appropriate bar within the **Call Sequence** area. DMP displays the related settings.

Call Sequence

**Call Sequence 1**

Repeat Call Sequence On Completion

Call Sequence Record

Call Sequence Record 1

Number of Call Attempts 3 ▼

Destination Index 0 ▼

Call Sequence Record 2

Number of Call Attempts 3 ▼

Destination Index 0 ▼

Call Sequence Record 3

Number of Call Attempts 3 ▼

Destination Index 0 ▼

- b. If the call sequence is to repeat from the beginning whenever it fails to connect to its destination monitoring centre, ensure the **Repeat Call Sequence On Completion** checkbox is ticked. Ensure it is clear if the sequence is not to repeat. For 4G units making calls to IP destination(s) this must be enabled.

**Note: 4G units configured with an IP destination MUST be set to repeat the call sequence to ensure reliable operation during mains power outages. Tunstall recommends that this option is enabled for all units.**

- c. For each call sequence record:
- Specify the number of attempts to be made to connect to the record's destination, before moving to the next call sequence record. For 4G units making calls to IP destination(s) this must be a minimum of 4 attempts.
  - Select the destination to be used at this point in the sequence from the **Destination Index** drop-down list.

**Note: The call sequence must include a telephone/tone protocol destination as a final step to protect against an IP data service not being available for an extended period.**

## 4.7 Stage 7 – Register and configure personal triggers and telecare sensors

This section describes how to register and configure triggers/sensors, so they prompt the Smart Hub to take appropriate action, including raising alarms to a monitoring centre.

The pendant radio trigger provided with the Smart Hub comes pre-registered, so this stage is not required if this is the only trigger/sensor.

- Within the Device Settings menu, select the **Sensor** menu option. This displays the triggers/sensors currently registered to the unit, either before installation or as part of the

installation process described in Section 3.6, Stage 6 – Prepare sensors for use as the virtual property exit sensor.

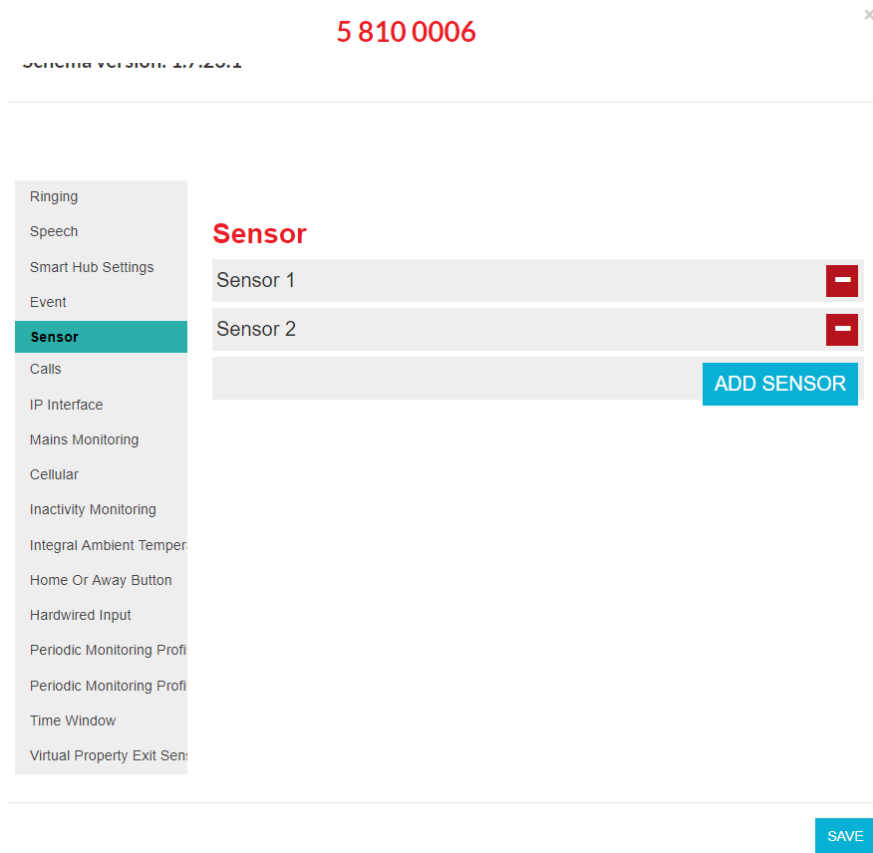

2. For each trigger/sensor listed:

- a. Click within the grey bar of the sensor line. DMP displays the selected trigger/sensor’s details. This may include additional fields to the ones shown below.

- b. Check that the details are correct.
- c. If required, use the **Sensor Location** drop-down list to distinguish the trigger/sensor from others of the same type. This can be by location, owner, or appliance/door type. This helps operators to provide the best response to an alarm.
- d. If the **Sensor Type** is “Door Contact” or “Passive Infrared (PIR)” and the sensor is to be used as part of the virtual property exit sensor, ensure **Enable Virtual Sensor** is ticked. At least one “Door Contact” and at least one “Passive Infrared (PIR)” must be defined as part of the virtual property exit sensor.
- e. If a trigger/sensor was added in error during the pre-installation preparation:
  - i) Click the  button at the end of the trigger/sensor’s entry. DMP displays a confirmation message:

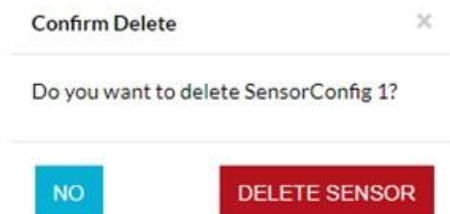

- ii) Click **DELETE SENSOR** to delete the trigger/sensor details from the list.



Only delete a trigger/sensor after confirming that the identifier on the DMP record matches that on the trigger/sensor’s label. Always check afterwards that the correct trigger/sensor has been deleted.

3. If you have any additional triggers/sensors to be registered, then for each trigger/sensor:
  - a) Press the **ADD SENSOR** button.
  - b) Enter the six-digit identification number of the new sensor/trigger in the **Sensor ID**.
  - c) Select its type from the **Sensor Type** drop-down list.
  - d) If required, uniquely identify the trigger/sensor by selecting a value from the **Sensor Location** drop-down list.
  - e) If required, select its **Enable Virtual Sensor** checkbox.

## 4.8 Stage 8 – Configure the virtual property exit sensor

This section describes how to configure the virtual property exit sensor so that it correctly triggers the Smart Hub to take appropriate action, including raising an alarm to the monitoring centre. This feature requires appropriate door and PIR sensors to be correctly configured.

To configure the settings that relate to the virtual property exit sensor:

- 1) Within the Device Settings menu, select the **Virtual Property Exit Sensor** menu option.

7205 810 0006 x

- Ringing
- Speech
- Smart Hub Settings
- Event
- Sensor
- Calls
- IP Interface
- Mains Monitoring
- Cellular
- Inactivity Monitoring
- Integral Ambient Temper
- Home Or Away Button
- Hardwired Input
- Periodic Monitoring Profi
- Periodic Monitoring Profi
- Time Window
- Virtual Property Exit Se

### Virtual Property Exit Sensor

**Enable Virtual Property Exit Sensor**

**Absence Period**

**Monday**

**Enable 24 Hour Monitoring**

**Start Time**

**End Time**

**Tuesday**

**Enable 24 Hour Monitoring**

**Start Time**

**End Time**

- 2) Use the **Enable Virtual Property Exit Sensor** checkbox to enable/disable this feature as required.

- 3) Enter the time period in minutes for which a unit will monitor for a return to the property after detecting an exit, in **Absence Period**. If the unit has not detected any return by the end of this time period, it raises a 'PES Client Wandered' event.
- 4) For each day of the week, specify when the virtual property exit sensor is to be active by either:
  - ensuring **Enable 24 Hour Monitoring** is ticked, or,
  - specifying the **Start Time** and **End Time** of the monitoring period

If **Enable 24 Hour Monitoring** is ticked, the unit ignores the values of the **Start Time** and **End Time** fields. If you specify a monitoring period where the **End Time** is less than the **Start Time**, then the end time occurs during the following day, for example from 11:00pm to 7:00am.

- 5) Take note of whether the virtual sensor is currently active and, if not, tick the appropriate **Enable 24 Hour Monitoring** checkbox so that the virtual sensor can be tested.

## 4.9 Stage 9 – Configure ambient temperature monitoring

**Note:** After first power-up, there is a stabilisation period where the Smart Hub does not monitor the ambient temperature. This normally lasts for 90 minutes. This is to prevent the unit from generating an alarm if the Smart Hub has been stored in a hot or cold environment prior to installation and has not yet stabilised.

To configure the settings that relate to the ambient temperature monitoring:

- 1) Within the Device Settings menu, select the **Integral Ambient Temperature Monitoring** menu option to display:

970264 4517 00123 57205 810 0006

- Ringing
- Speech
- Smart Hub Settings
- Event
- Sensor
- Calls
- IP Interface
- Mains Monitoring
- Cellular
- Inactivity Monitoring
- Integral Ambient Temp
- Home Or Away Button
- Hardwired Input
- Periodic Monitoring Profi
- Periodic Monitoring Profi
- Time Window
- Virtual Property Exit Sen

### Integral Ambient Temperature Monitoring

Suppress Temperature Monitoring At Night	<input checked="" type="checkbox"/>
Low Temperature (°C)	<input type="text" value="10"/>
High Temperature (°C)	<input type="text" value="30"/>
Enable Temperature Monitoring	<input type="checkbox"/>

SAVE



- 2) Use the **Enable Temperature Monitoring** checkbox to enable/disable this feature, as required.
- 3) If monitoring is to be restricted to daytime only, ensure the **Suppress Temperature Monitoring At Night** checkbox is ticked; otherwise ensure it is clear.
- 4) Set the low and high temperature thresholds appropriate for the user and local policies.

## 4.10 Stage 10 – Configure inactivity monitoring

To configure the settings that relate to inactivity monitoring:

1. Within the Device Settings menu, select the **Inactivity Monitoring** menu option to display:

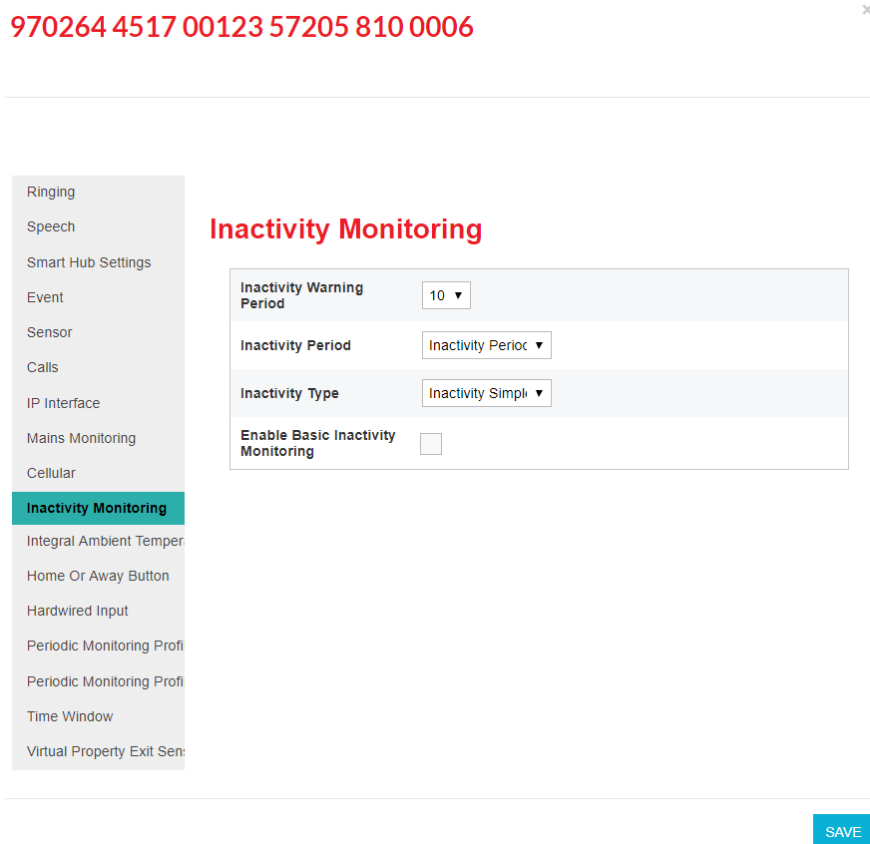

2. To enable inactivity monitoring, ensure that the **Inactivity Type** drop-down list is set to “Inactivity Simple” and that the **Enable Basic Inactivity Monitoring** checkbox is ticked. To disable it, set up these attributes with any other values.
3. If inactivity monitoring is enabled, select the length of inactivity that causes an inactivity warning period to start, that is, either 12 or 24 hours, from the **Inactivity Period** drop-down list.
4. If inactivity monitoring is enabled, select the length of the inactivity warning period, in minutes, from the **Inactivity Warning Period** drop-down list.

## 4.11 Stage 11 – Configure hardwired input

To configure any hardwired input:

1. Within the Device Settings menu, select the **Hardwired Input** menu option to display:

970264 4517 00123 57205 810 0006

**Hardwired Input**

Hardwired Input Mode	Disabled
Connected Device	Personal Trigg
Location	Unspecified Lo

SAVE

2. Select the normal state of the input, either, “Normally Open” or “Normally Closed”, from the **Hardwired Input Mode** drop-down list.
3. Use **Connected Device** to specify the type of the hardwired trigger/sensor.
4. If required, use the **Location** drop-down list to distinguish the trigger/sensor from others of the same type. This could be by location, owner, or appliance/door type.

## 4.12 Stage 12 – Configure Cancel At Source feature

Cancel At Source is a feature which allows an alarm to be repeated at a set interval until a full cancellation action is taken physically at the Smart Hub unit. This can be used to ensure high dependency clients are visited by a carer prior to an alarm being fully closed.

Alarms are raised to the monitoring centre and the calls cleared by the operator in the usual manner. If the configured alarm is not cancelled locally at the Smart Hub, then repeat calls to the monitoring centre will automatically be made.

Whilst an alarm is pending local cancellation, the yellow **Home/Away** button surround will flash slowly. Upon arrival, a carer then presses the green **Cancel** button to fully cancel the alarm, thus preventing repeat calls.

To use the Cancel At Source feature:

- 1) Within the **Device Settings** menu, select the **Cancel At Source** menu option to display:

## Cancel At Source

<b>Repeat Timer</b>	<input type="text" value="30"/>
<b>Alarm Code</b>	<input type="text" value="Same"/> ▾
<b>Alternate Alarm Code</b>	<input type="text"/>
<b>CAS Mode</b>	<input type="text" value="Event"/> ▾
<b>Raise Carer Arrived On Cancel</b>	<input type="checkbox"/>
<b>Number Of Repeats</b>	<input type="text" value="0"/>

- 2) Set the interval between alarm repeats to the desired number of minutes. This would normally be set in accordance with local policy, considering the dependency level of the client and the likely time it will take for a carer to attend.
- 3) Select the **Raise Carer Arrived On Cancel** checkbox if a 'Carer Arrived' event is to be generated upon the alarm being cancelled at the Smart Hub unit. This feature can be used to confirm the cancellation by raising a 'Carer Arrived' notification to the monitoring centre.
- 4) If required, select the maximum number of repeat calls which can be made for each alarm. Value 0 indicates that there is no limit and repeat calls will be made until manual cancellation occurs.
- 5) Select from the **CAS Mode** drop-down, the default selection is 'Event', to enable the cancel at source feature for alarm events.
- 6) Within the **Device Settings** menu select the **Event** menu, now select the events that required the cancel at source alarm mode.
- 7) In the example below, the 'Help Button' is configured to require a Cancel At Source. This can be repeated for other events by selecting from the **Alarm Mode** drop-down: 'Cancel At Source'.

**Note:** If the "RAISE CARER ARRIVED ON CANCEL" checkbox is selected, both 'Carer Arrived' and 'Carer Non-Arrival' will need to be configured from the **EVENT** Device Settings menu, to fully set up the Cancel At Source feature.

## Event

### Help Button

Raise Alarm In Away Mode	<input checked="" type="checkbox"/>
Raise Alarm In Home Mode	<input checked="" type="checkbox"/>
Answer Incoming Call	<input type="checkbox"/>
Audible Reassurance	<input checked="" type="checkbox"/>
Visual Reassurance	<input checked="" type="checkbox"/>
Call Sequence Index	1 ▾
Number Of Prealarm Announcements	1 ▾
Inactivity System Input	<input checked="" type="checkbox"/>
Enable Microphone On Alarm Calls	<input checked="" type="checkbox"/>
Enable Speaker On Alarm Call	<input checked="" type="checkbox"/>
Alarm Mode	Cancel At Sourc ▾
Relay Behaviour	No Action ▾

**Note:** In the event of multiple alarms being raised concurrently, only the original will generate Cancel At Source repeats until it is manually cancelled. The concurrent alarms will still be raised and need to be closed by the monitoring centre.

As detailed in section 4.14, it is possible to configure time windows during which specified events will not be raised as alarms by the Smart Hub unit. Where a sensor that has been configured for a Cancel At Source response is triggered, and repeat alarms fall during the blocking period, the time window settings will take precedence over the Cancel At Source settings and alarm repeats will be paused until the blocking period has elapsed.

**Note:** To avoid undesirable results, it is recommended that Cancel At Source mode is only used with radio trigger, red Help button, inactivity, virtual property exit sensor and hardwired input events. It should not be used for 'technical' alarms, such as those reporting sensor low batteries, auto presence or mains power failures, for example.

## 4.13 Stage 13 – Configure events

For a list of the events and the typical default settings of their attributes, refer to Appendix G, [List of typical default Smart Hub event settings](#). However, Tunstall may deliver Smart Hubs with different defaults according to local requirements, or your organisation may automatically apply a template on receipt of each device which updates this configuration.

To configure events:

1. Within the Device Settings menu, select the **Event** menu option to display:

**290883 1218 00131 57200 810 0005**



Ringing	<h3 style="color: red;">Event</h3> <ul style="list-style-type: none"> <li>Help Button</li> <li>Cancel Button</li> <li>Away Button</li> <li>Inactivity Alarm</li> <li>Periodic Call (IP)</li> <li>Periodic Call (GSM)</li> <li>Mains Power Fail</li> <li>Mains Power Restored</li> <li>System Battery Low</li> <li>Stuck Key</li> <li>Unit Failure</li> <li>Battery Charged</li> <li>Away State Entry</li> </ul>
Speech	
Smart Hub Settings	
<b>Event</b>	
Sensor	
Calls	
IP Interface	
Mains Monitoring	
Cellular	
Inactivity Monitoring	
Integral Ambient Temper	
Home Or Away Button	
Hardwired Input	
DMP	
Periodic Monitoring Profi	
Periodic Monitoring Profi	
Time Window	
Virtual Property Exit Sen	
Cancel At Source	

2. Select the event to be updated to display its configuration settings. Each event has the same set of attributes, as shown below:

Raise Alarm In Away Mode	<input checked="" type="checkbox"/>
Raise Alarm In Home Mode	<input checked="" type="checkbox"/>
Answer Incoming Call	<input type="checkbox"/>
Audible Reassurance	<input checked="" type="checkbox"/>
Visual Reassurance	<input checked="" type="checkbox"/>
Call Sequence Index	1 <input type="button" value="v"/>
Number Of Prealarm Announcements	1 <input type="button" value="v"/>
Inactivity System Input	<input checked="" type="checkbox"/>
Enable Microphone On Alarm Calls	<input checked="" type="checkbox"/>
Enable Speaker On Alarm Call	<input checked="" type="checkbox"/>
Alarm Mode	Standard Alarm <input type="button" value="v"/>
Relay Behaviour	No Action <input type="button" value="v"/>

3. Update the drop-down lists and checkboxes, as required. The most common changes you may need to make are:
  - Setting **Relay Behaviour** of the hardwired output event to suit installation specific circumstances
  - Setting **Audible Reassurance** to either enabled or disabled to suit the installation and user’s circumstances
  - Changing the **Call Sequence Index** where there are multiple call sequences used by your organisation
  - Changing **Alarm Mode** to ‘Cancel At Source’ if this type of response is appropriate (see section 4.12).
4. Repeat steps 2 and 3 for each event that requires amendment.

## 4.14 Stage 14 – Configure event suppression

You can configure the Smart Hub to block a type of event that occurs within a specific time window so that alarms relating to the event are not raised during that period. The types of event that can be blocked are:

- TES - Low Temp
- Door Usage Opening
- Door Usage Closing
- Pressure Mat Activation
- Enuresis Activation.

To define the alarms and time periods during which blocking occurs:

1. Within the Device Settings menu, select the **Time Window** menu option to display:

970264 4517 00123 57205 810 0006

The screenshot displays the 'Time Window' configuration page. On the left is a sidebar menu with options: Ringing, Speech, Smart Hub Settings, Event, Sensor, Calls, IP Interface, Mains Monitoring, Cellular, Inactivity Monitoring, Integral Ambient Temperature, Home Or Away Button, Hardwired Input, Periodic Monitoring Profile, Periodic Monitoring Profile, **Time Window**, and Virtual Property Exit Sensor. The main content area is titled 'Time Window' and contains two identical configuration blocks, 'Time Window 1' and 'Time Window 2'. Each block includes:
 

- 'Event Suppression Start Time' field: 00:00
- 'Event Suppression End Time' field: 00:00
- 'Event Type' dropdown menu: TES: Low Temp
- 'Enabled' checkbox: unchecked

2. For each combination of event and time period during which the event is to be blocked:
  - a. Specify the **Event Suppression Start Time** and **Event Suppression End Time** of the blocked period. If you enter an **Event Suppression End Time** that is less than the **Event Suppression Start Time**, then the end time occurs during the following day, for example from 11:00pm to 7:00am.
  - b. Select the type of event that is to be blocked from the **Event Type** drop-down list.
  - c. Select **Enabled** to implement the blocking.

## 4.15 Stage 15 – Configure the Home or Away feature

To configure the settings that relate to the Home or Away feature:

1. Within the Device Settings menu, select the **Home Or Away Button** menu option to display:

970264 4517 00123 57205 810 0006 x

---

- Ringing
- Speech
- Smart Hub Settings
- Event
- Sensor
- Calls
- IP Interface
- Mains Monitoring
- Cellular
- Inactivity Monitoring
- Integral Ambient Temper
- Home Or Away Button**
- Hardwired Input
- Periodic Monitoring Profi
- Periodic Monitoring Profi
- Time Window
- Virtual Property Exit Sen

### Home Or Away Button

Button Function	Home Or Away ▾
Delay Before State Change	15
Away State Reminder	<input type="checkbox"/>

SAVE

2. Update the **Button Function** checkbox to indicate whether the Home and Away feature is implemented.
3. If required:
  - a. Specify the time delay in seconds between switching between Home and Away modes after the yellow **Home/Away** button has been pressed.
  - b. Specify whether reminders to return to Home mode are to be played whenever the unit is in Away mode and detects activity in the property.



## 4.16 Stage 16 – Configure periodic calls

**Note: Fields relating to periodic calls should not be changed without discussion with your supplier.**

To configure the settings that relate to periodic calls:

1. If periodic calls are to be made using IP protocols:
  - a. Within the Device Settings menu, select the **Periodic Monitoring Profile On Mains** menu option to display:

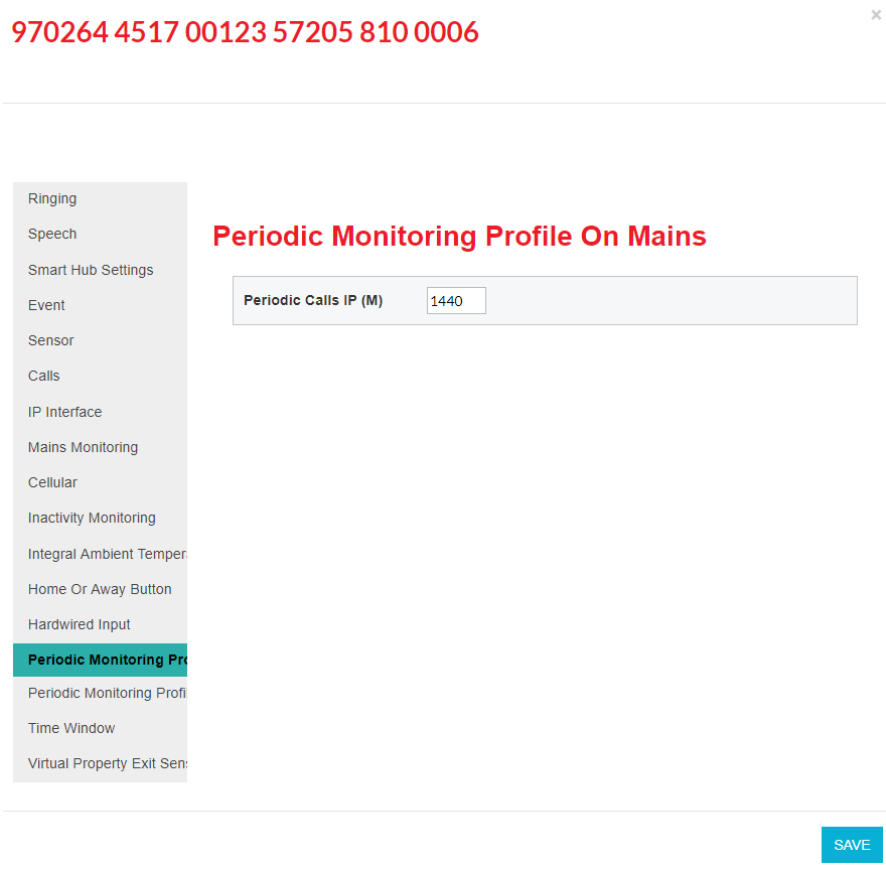

- b. If required, set the interval in minutes for IP periodic calls whilst the unit is on mains power. This should only be done after discussion with your supplier.

- c. Select the **Periodic Monitoring Profile On Battery** menu option to display:

970264 4517 00123 57205 810 0006

x

The screenshot shows a configuration page titled "Periodic Monitoring Profile On Battery". On the left is a vertical menu with the following items: Ringing, Speech, Smart Hub Settings, Event, Sensor, Calls, IP Interface, Mains Monitoring, Cellular, Inactivity Monitoring, Integral Ambient Temper, Home Or Away Button, Hardwired Input, Periodic Monitoring Profile (highlighted in teal), Time Window, and Virtual Property Exit Sen. The main content area contains a single input field labeled "Periodic Calls IP (M)" with the value "1440". At the bottom right of the page is a blue "SAVE" button.

- d. If required, set the interval in minutes for IP periodic calls whilst the unit is on battery. This should only be done after discussion with your supplier.

2. If the periodic calls are to be made using GSM telephony (tone protocols):
  - a. Within the Device Settings menu, select the **Smart Hub Settings** menu option to display:

290802 2417 00153 57200 810 0005

- Ringing
- Speech
- Smart Hub Settings
- Event
- Sensor
- Calls
- IP Interface
- Mains Monitoring
- Cellular
- Inactivity Monitoring
- Integral Ambient Temper
- Home Or Away Button
- Hardwired Input
- DMP
- Periodic Monitoring Profil
- Periodic Monitoring Profil
- Remote Logging
- Time Window
- Virtual Property Exit Sen
- Cancel At Source

### Smart Hub Settings

Time Zone	Europe - Londo <span style="font-size: small;">▼</span>
Enable Radio Blocking	<input type="checkbox"/>
Time For GSM Periodic Call	<input type="text" value="00:00"/>
Periodic Calls GSM (D)	<input type="text" value="0"/>
Lock Release Duration	<input type="text" value="0"/>

- b. Set **Periodic Calls GSM** to the number of days' interval between the test calls. If no calls are required, set **Periodic Calls GSM** to zero.
3. Within the Device Settings menu, select the **Calls** menu option.
4. Either check that the required call sequence(s) are available or create new call sequence(s) to be used for periodic calls, as described in Section 4.6, [Stage 6 – Configure monitoring centre setting](#). By convention, call sequence indexes 9 and 10 are used for periodic calls.



'Telephone' destinations (GSM/tone protocol destinations) should not appear in the call sequence used by IP protocol periodic calls. Similarly, IP call destinations should not appear in the call sequence used by telephone periodic calls.

5. Within the Device Settings menu, select the **Event** menu option and open the Periodic Call (IP) Event or the Periodic Call (GSM) Event, as appropriate. DMP displays the same fields for each event. The Periodic Call (IP) Event is shown below to illustrate the fields.

970264 4517 00122 57205 810 0007

**Event**

Help Button

Cancel Button

Away Button

Inactivity Alarm

**Periodic Call (IP)**

Raise Alarm In Away Mode	<input checked="" type="checkbox"/>
Raise Alarm In Home Mode	<input checked="" type="checkbox"/>
Answer Incoming Call	<input type="checkbox"/>
Audible Reassurance	<input type="checkbox"/>
Visual Reassurance	<input checked="" type="checkbox"/>
Call Sequence Index	9 ▼
Number Of Prealarm Announcements	1 ▼
Inactivity System Input	<input type="checkbox"/>
Enable Microphone On Alarm Calls	<input type="checkbox"/>
Enable Speaker On Alarm Call	<input type="checkbox"/>
Alarm Mode	Standard Alarm ▼
Relay Behaviour	No Action ▼

6. Select the required **Call Sequence Index**. By convention, organisations use call sequence indexes 9 and 10 for periodic calls.
7. Ensure **Raise Alarm in Away Mode** and **Raise Alarm in Home Mode** are ticked.
8. If the unit is to make periodic calls for both IP and GSM protocols, repeat steps 5 to 7 for the other periodic call event.

## 4.17 Stage 17 – Configure power fault monitoring settings

To configure the power fault monitoring settings:

1. Within the Device Settings menu, select the **Mains Monitoring** menu option to display:

970264 4517 00123 57205 810 0006 ×

---

- Ringing
- Speech
- Smart Hub Settings
- Event
- Sensor
- Calls
- IP Interface
- Mains Monitoring**
- Cellular
- Inactivity Monitoring
- Integral Ambient Temper
- Home Or Away Button
- Hardwired Input
- Periodic Monitoring Profi
- Periodic Monitoring Profi
- Time Window
- Virtual Property Exit Sen

### Mains Monitoring

<b>Allow Immediate Mains Fail Alarm</b>	<input type="checkbox"/>
<b>Mains Power Fail Random Time Out Period (H)</b>	1 ▾
<b>Enable Mains Failure And Restoration Audible Warning</b>	<input checked="" type="checkbox"/>
<b>Mains Failure Call Frequency (H)</b>	4 ▾
<b>Mains Restore Random Time Out Period (H)</b>	1 ▾

SAVE

2. Ensure the **Allow Immediate Mains Fail Alarm** checkbox is clear, unless the monitoring centre is to be immediately advised of mains power failure.

**Note:** Tunstall recommend you enable this option only for selected, high-risk clients; otherwise, an area outage may result in the monitoring centre ‘flooding’ with simultaneous calls from devices in the area.

3. If required by the user and if under your organisational policies, select the **Enable Mains Failure And Restoration Audible Warning** checkbox so that the unit announces any mains failure and subsequent restoration.

## 4.18 Stage 18 – Configure line ringing settings

To configure the line ringing settings that relate to the calls made to the unit by the monitoring centre or other telecare-related source:

1. Within the Device Settings menu, select the **Ringing** menu option to display:

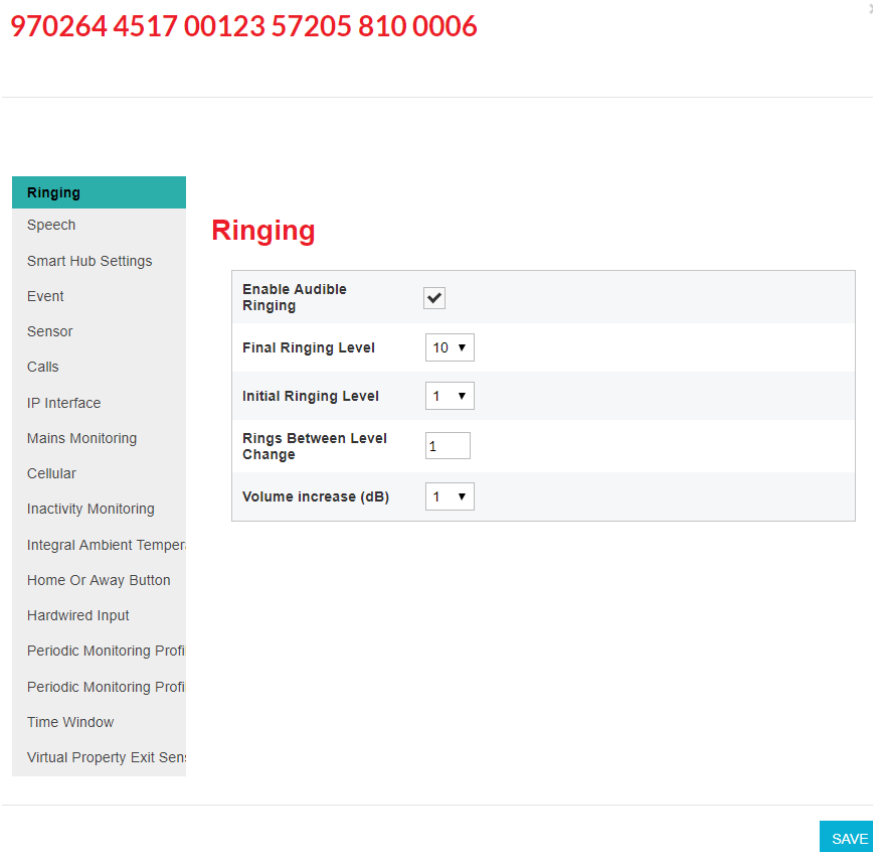

2. Ensure **Enable Audible Ringing** is ticked.
3. Select appropriate values for the remaining fields after discussion with the user of the unit.

## 4.19 Stage 19 – Configure DMP update announcements

To suppress announcements during update of the unit’s firmware or configuration settings:

1. Within the Device Settings menu, select the **DMP** menu option to display:

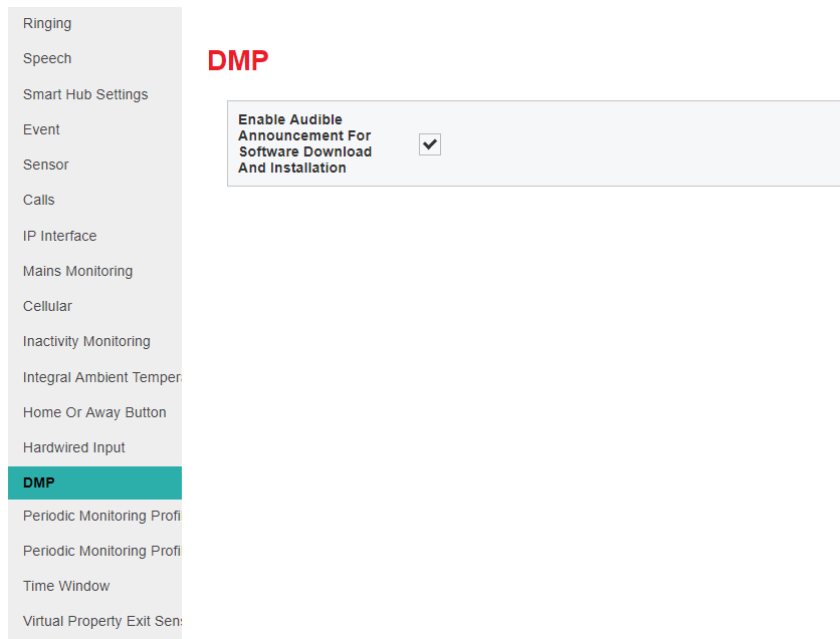

2. Ensure the **Enable Audible Announcement For Software Download and Installation** checkbox is clear.

## 4.20 Stage 20 – Save changes to DMP

Once you have completed defining the Smart Hub’s configuration, you then go on to save these changes in the Smart Hub’s DMP record and communicate them to the unit. To do this:

1. Within the Device Settings window, click the **SAVE** button.

DMP presents a summary of the accumulated changes. This may extend over multiple pages.

970264 4517 00123 57205 810 0006

### Summary

Show  entries

Search:

Showing 1 to 5 of 5 entries

SETTINGS NAME	OLD VALUE	NEW VALUE
Ring > Initial Ringing Level	1	3
Ring > Rings Between Level Change	1	2
Speech > Fault Monitoring > No Fault Monitoring Speech End Time	08:00	09:00
Speech > Fault Monitoring > No Fault Monitoring Speech Start Time	22:00	23:00
Speech > Plug and Play > Announce Prefix	false	true

Showing 1 to 5 of 5 entries

CANCEL

SAVE

2. Check that the changes are correct and complete.
3. If they are not, click **CANCEL**, make the required changes as described in the previous sections and then repeat this procedure.
4. If the changes are correct and complete, click the **SAVE** button. DMP displays a verification pop-up:

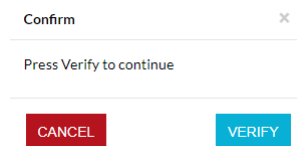

5. Authorise the changes by clicking the **VERIFY** button.

Once the changes have been saved, you see the following confirmation pop-up:

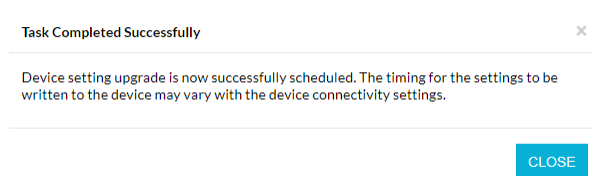

6. Click **Close**.

The device is now 'locked' against further configuration changes until the current set is downloaded and installed on the Smart Hub, as indicated by the following message displayed on the Device Settings window:

**970264 4517 00123 57205 810 0006**

The device is locked for updates since Tue, 31 Jul 2018 09:29

7. Click **X** to close the Device Settings window and return to the Device Information window.
8. Press the green **Cancel** button on the Smart Hub to prompt a DMP connection.

DMP downloads the amended settings for the Smart Hub to install. Whilst the download and update are taking place, the device has a 'technical' status, indicated by the blue traffic light icon in DMP. On successful completion of the settings update, the status changes to 'OK', indicated by a green traffic light icon. The Smart Hub announces, "New device settings applied" to confirm the application of the new settings soon after they have been applied.

9. Click **X** to close the Device Information window, and then log out of DMP.

This completes the configuration of the Smart Hub and you should now go on to test the unit as described in the following chapter.



## 5 Testing the installation

### 5.1 Stage 1 – Test the range of personal triggers/telecare sensors registered using DMP

Following the steps described in Section 3.8, [Stage 7 – Test the range of personal triggers/telecare sensors](#), test the range of any trigger/sensor you registered using DMP.

### 5.2 Stage 2 – Test alarm calls

**Note:** This stage assumes that the preferred IP destinations of the unit's call sequences use an Ethernet communication channel. If the Smart Hub is not configured in this way, adapt this test procedure by following the instructions purely through the cellular channel.

To test that the appropriate alarm calls are raised:

1. Press the red **Help** button on the Smart Hub.
2. Verify that your action raises the correct alarm call and that you receive confirmation from the operator at the monitoring centre.
3. Liaise with the monitoring centre operator to adjust the volume of the operator's voice over the unit's speaker for appropriate audio level and clarity. The operator controls this volume.
4. Ensure the monitoring centre has the relevant client details, such as the name of the unit user and the address where the unit is installed.
5. Clear the alarm call raised in step 1 and then press the red button of the supplied pendant.
6. Confirm that your action raises the appropriate alarm call and that the call goes through to the monitoring centre.
7. Test any other telecare sensors/personal triggers monitored by the Smart Hub, including hardwired input devices. Ensure that the appropriate alarm call goes through to the monitoring centre with the correct sensor/trigger details.
8. Disconnect the Ethernet cable, forcing the unit to use a cellular channel.
9. Press the red **Help** button on the Smart Hub.
10. Confirm that your action raises the appropriate alarm call and that you receive confirmation that the call reached the monitoring centre by the operator answering the call.
11. Reconnect the Ethernet cable. Testing is now complete.

## 5.3 Stage 3 – Test virtual property exit sensor

If the installation includes the virtual property exit sensor, you complete a function test it as follows:

1. Simulate a person leaving the property by each of the doors covered by the virtual sensor and check that the correct alarm is raised in each instance. Ensure there is no movement within the vicinity of the virtual property sensor's PIR(s) during the absence period.
2. It may be necessary to turn on the monitoring for test purposes, to do this:
  - a. Log in and go to the Device Settings screen as described in Section 4.1, [Stage 1 – Log on to DMP and access the configuration settings](#).
  - b. Clear today's **Enable 24 Hour Monitoring** checkbox as described in Section 4.8, [Stage 8 – Configure the virtual property exit sensor](#).
  - c. Save the amended setting, download it and install it on the Smart Hub as described in Section 4.20, [Stage 20 – Save changes to DMP](#).

## 5.4 Stage 4 – Test hardwired output

If there is a hardwired output device, you must test that it is activated by the Smart Hub upon the required event. The steps required to perform this test are dependent on how the trigger device and its associated event are configured within DMP.

## 5.5 Stage 5 – Ready to use

Once you have successfully tested the Smart Hub installation, you should record the unit as tested and operational.

The Smart Hub is now ready for you to instruct the user on operating the unit. This instruction should also include a warning that the unit must not be moved from its current position without informing the service provider.



Moving the unit without informing the service provider can put the user at risk, as the service provider may not be able to assist in an emergency.

---

## A Powering down the Smart Hub

The Smart Hub unit must be fully powered down when being uninstalled and transported, to avoid possible safety and security issues. The unit has an internal battery, which may inadvertently trigger warnings and announcements through its mobile phone technology after it has been installed.

To power down a unit:

1. Ensure the unit is operating on mains power.
2. Press and hold down the green **Cancel** button.

After 5 seconds, the unit beeps to indicate it has entered 'Programming Mode'. Continue to hold down the green **Cancel** button.

3. When the Smart Hub announces, "Remove the Power Cable" and the LEDs flash, release the green **Cancel** button. This happens after approximately 13 seconds.
4. Remove the power connector from the rear of the Smart Hub, or disconnect it from the mains power supply, within 5 seconds of the message starting.

**Note: If you do not perform this step within the 5 second timeframe, the Smart Hub restarts on battery power. In this case, re-connect the mains power and repeat the process from step 1.**

5. Check that all the buttons, illuminations and other indicators remain off and the red **Help** button does not begin to flash every 4 seconds, indicating continued operation on battery power.

## B Smart Hub announcements

This appendix lists the announcements that may occur during installation, together with their probable cause and suggested actions.

**Note: The unit repeats some critical warning messages until acknowledged. This ensures that the situation is not missed. To acknowledge and stop the repeating of the announcement, press the green Cancel button. If the warning announcement persists, please contact your supplier.**

Announcement	Probable cause and suggested actions
Alarm call completed	Normal operational message. Heard when the alarm has been cleared by the monitoring centre operator.
Applying new device settings	Changed settings have been prepared for the Smart Hub through the Device Management Platform (DMP). These have been downloaded and are being updated. No action required.
Away	Normal operational message. Yellow <b>Home/Away</b> button has been pressed and unit is now in Away mode.
Battery low	Heard when a Smart Hub is first powered up, if it has been in storage for an extended period, or after a long mains power failure. Check the Smart Hub is plugged into a working electrical socket and allow time for the battery to charge.
Cellular data connection failure	The unit is unable to connect to a cellular data service. If the cellular network is known to be operational or the situation persists, contact your supplier.
Cellular data connection restored	Cellular coverage has reconnected. No action required.
Connected to DMP	The Smart Hub has been able to connect to DMP. This should be heard if the green <b>Cancel</b> button is pressed whilst no alarm is pending. No action required.
Connected to monitoring centre	Normal operational message. Heard when the protocol and monitoring centre use a call back method for speech operation. Expect an operator to speak shortly afterwards.
Connection attempt to DMP failed	The Smart Hub is unable to connect to DMP. This indicates that no IP communication method is available, and/or the unit cannot reach DMP. Check that internet communications are available through the router/cellular service and that the DMP service is active.
Do not worry, contacting assistance	Normal operational message. Indicates that an alarm call connection to the monitoring centre has been initiated. At this point, the alarm can no longer be cancelled.
Ethernet connection failure	The unit is no longer connected to the router. Check the Ethernet cable and router.



Announcement	Probable cause and suggested actions
Ethernet connection restored	The Ethernet connection is restored, and the unit can now communicate with the router. No action required.
External antenna selected	Heard after yellow <b>Home/Away</b> button has been held depressed for 10 seconds. The Smart Hub has switched antenna connection from internal to external. This mode should only be used when an external antenna is fitted.
Home	Normal operational message. Yellow <b>Home/Away</b> button has been pressed and unit is now in 'Home mode'.
Incoming call. Press pendant or <b>Cancel</b> button to accept the call	Normal operational message. This is heard when the alarm unit is receiving a call (ringing).
Internal antenna selected	Heard after yellow <b>Home/Away</b> button has been held depressed for 10 seconds. The Smart Hub has switched antenna connection from external to internal.
New device settings applied	Updated settings have been applied and are in use. No action required.
No mobile network coverage	The Smart Hub is not able to connect to a cellular network. Check the internal/external antenna selection is correct. For 2G/3G Smart Hubs, try using or re-positioning an external antenna. Check if a suitable network signal should be available using another device or information provided by the network/your supplier.  The Smart Hub should not be relied upon in this condition.
Pendant activation	An alarm has been initiated using a radio pendant.
Please wait while we connect you to an operator	Normal operational message. Provides continued reassurance that an alarm is being progressed. This will be repeated until a connection with the monitoring centre is achieved.
Please wait, measuring signal strength	May be heard after yellow <b>Home/Away</b> button has been held depressed for six seconds. The Smart Hub is measuring strength of cellular signal prior to announcing the signal strength.
Please wait...	Normal operational message. The call is being presented to operators and awaiting selection. Expect an operator to speak shortly afterwards.
Press <b>Cancel</b> button to cancel the alarm	Normal operational message. Heard during an alarm, if the green <b>Cancel</b> button is pressed, the alarm in progress is cancelled.
Programming mode	Green <b>Cancel</b> button has been used to enter programming mode. This mode allows the range of radio devices to be tested without raising alarms.

Announcement	Probable cause and suggested actions
Red button	An alarm has been initiated using the red <b>Help</b> button.
Reduction in radio range detected	This may happen in the presence of strong radio interference impeding the ability to receive signals from radio peripheral devices. Check that the Smart Hub is not close to any other electrical devices such as a computer, television, fan or mobile phone. If so, turn off or move the equipment away from the Smart Hub and check if this stops the warning. Contact the supplier if this does not resolve the issue.
Registration mode	Green <b>Home/Away</b> button has been used to enter registration mode. This mode allows new radio devices to be registered.
Remove the power cable	Heard after the green <b>Cancel</b> button has been held depressed for ten seconds, signifying opportunity to shut-down the unit (if power cable is removed promptly) ready for transportation.
Signal strength is... <1 to 31>	Heard after yellow <b>Home/Away</b> button has been held depressed for six seconds. The Smart Hub is indicating strength of cellular network signal.
SIM card locked	The SIM card is locked, preventing use, after too many attempts to use with an incorrect security PIN. Contact the Smart Hub and SIM card supplier.
SIM card PIN error	The SIM card has a security protection for which the Smart Hub has not been configured. Contact the Smart Hub and SIM card supplier.
SIM card removed	The SIM card has been removed from the Smart Hub. Re-insert SIM card. After SIM card insertion, it may take a few minutes to reconnect to a mobile network (allow five minutes if operating on battery power).
Software download started/paused/resumed/completed/failed	The Smart Hub is in the process of obtaining updated firmware. No action required. If the download fails, the unit continues to operate with the original firmware. In this case, a further attempt to update the unit should be scheduled. The status is known to the service provider through DMP.
Software installation started/completed/failed	The Smart Hub is in the process of installing new software it has already downloaded. No action required. If the installation fails, the unit continues to operate with the original firmware. In this case, a further attempt to update the unit should be scheduled. The status is known to the service provider through DMP.
The alarm call has been cancelled	Normal operational message. Heard after using the green <b>Cancel</b> button to cancel an alarm before connection to a monitoring centre is attempted.



Announcement	Probable cause and suggested actions
The alarm call sequence has ended	An alarm has occurred, and the Smart Hub has tried to contact a monitoring centre but not been successful. Press the green <b>Cancel</b> button to acknowledge and stop the message repeating. Contact the Service Provider and check that the Smart Hub's call sequences and destinations are correctly programmed.
The mains power is restored	Occurs after power has been reconnected to the Smart Hub. No action required.
There is no mains power	Occurs after power is disconnected. Check the Smart Hub is plugged into a working electrical socket.

## C Status of the Smart Hub

The main function of DMP is to monitor that devices are functioning correctly. This is done automatically by constantly observing for heartbeats from each device. The health of a unit is represented by traffic light icons. For details on the properties that control change of status, refer to the *Device Management Platform Reference Guide*.

Heartbeat	Meaning
	<p>The device is functioning correctly and is sending heartbeats at the interval expected by the device’s district. The district property that defines the expected heartbeat interval is:</p> <ul style="list-style-type: none"> <li>• <b>Heartbeat interval (minutes)</b></li> </ul>
	<p>The device sends heartbeats but has a technical status, for example:</p> <ul style="list-style-type: none"> <li>• there is a mains power failure, the battery charge is low or there is a battery error</li> <li>• the device is in the process of updating its firmware or settings.</li> </ul> <p>You can get information about the cause of the technical status by hovering the cursor above the icon.</p>
	<p>The status of the device is unclear. Circumstances that set the heartbeat icon to this status include:</p> <ul style="list-style-type: none"> <li>• a temporary communication problem</li> <li>• low cellular signal level</li> <li>• SIM Card removed – Ethernet still connected</li> <li>• a registered device that is not turned on, that is, before the device sends its first heartbeat</li> <li>• the device is connected incorrectly.</li> </ul> <p>DMP displays a yellow icon when no heartbeat is received for a time period defined by the device’s district. The properties that control this change of status are:</p> <ul style="list-style-type: none"> <li>• <b>Warning interval (minutes)</b>, if the device is using mains power</li> <li>• <b>Warning (on power failure) interval (minutes)</b>, if the device is using batteries.</li> </ul>



Heartbeat	Meaning
	<p>This indicates there is an error requiring action e.g., the device is switched off or is out of touch with the outside world.</p> <p>DMP displays a red icon when no heartbeat is received for a time period defined by the device's district. The properties that control this change of status are:</p> <ul style="list-style-type: none"><li>• <b>Error interval (minutes)</b>, if the device is using mains power</li><li>• <b>Error (on power failure) interval (minutes)</b>, if the device is using batteries.</li></ul>
	<p>This indicates the device has been set to 'Inactive' within DMP, that is, has been temporarily taken out of service.</p>

# D Applying a template to a device

To apply a template to a device:

1. Log on to DMP and display the required Smart Hub on the **View Devices List** page as described in steps 1 to 5 of Section 4.1, [Stage 1 – Log on to DMP and access the configuration settings](#).

Customer: Tunstall Documentation 2 | District: 02 Customer Service Returns

Show advanced filter

Show 50 entries | Showing 1 to 1 of 1 entries | Search: [ ]

STATUS	SERIAL NUMBER	SOFTWARE VERSION	BATTERY LEVEL	SIGNAL STRENGTH	LAST CONTACT	PRIMARY ARC ID	PRODUCT
ON	970264 4517 00123 57205 810 0006	5.2.0	100%	●●○○○	Wed, 15 Aug 2018 08:25	4108888812	Vi-IP 869

Showing 1 to 1 of 1 entries

2. Select the checkbox at the start of the details of the device. DMP displays three additional buttons above the list of devices.

Customer: Tunstall Documentation 2 | District: 02 Customer Service Returns

MIGRATE DEVICES (1) | UPGRADE FIRMWARE (1) | SET SETTINGS TEMPLATE (1)

Show advanced filter

Show 50 entries | Showing 1 to 1 of 1 entries | Search: [ ]

STATUS	SERIAL NUMBER	SOFTWARE VERSION	BATTERY LEVEL	SIGNAL STRENGTH	LAST CONTACT	PRIMARY ARC ID	PRODUCT
<input checked="" type="checkbox"/>	970264 4517 00123 57205 810 0006	5.2.0	100%	●●○○○	Wed, 15 Aug 2018 08:25	4108888812	Vi-IP 869

Showing 1 to 1 of 1 entries

3. Click the **SET SETTINGS TEMPLATE** button. DMP opens the **Assign Template** window.

## Assign template

970264451700123572058100006

Template Name: Vi-IP-AB-TemplateTest1

CLOSE

APPLY TEMPLATE

4. Select the required template and then click **APPLY TEMPLATE**.
5. Press the device's green **Cancel** button to prompt a DMP connection and initiate the download of the template settings.
6. Whilst the download and settings update are taking place, the device has a technical status, indicated by the blue traffic light icon in DMP. On successful completion of the update, the status changes to 'OK', indicated by a green traffic light icon.

## E DMP online help

The online help within DMP is provided by the Albert AI Assistant.

You can access it by clicking the **Help?** button that appears in the bottom right-hand corner of the DMP page:

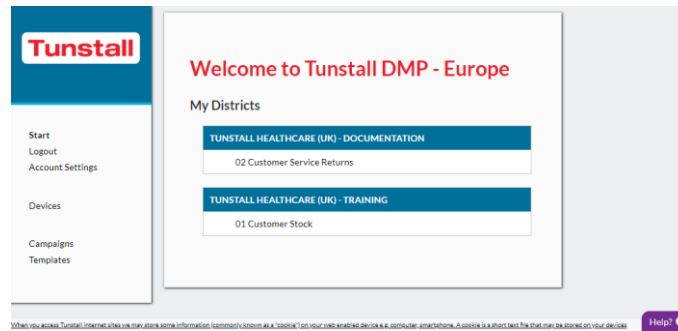

DMP opens a new pop-up window:

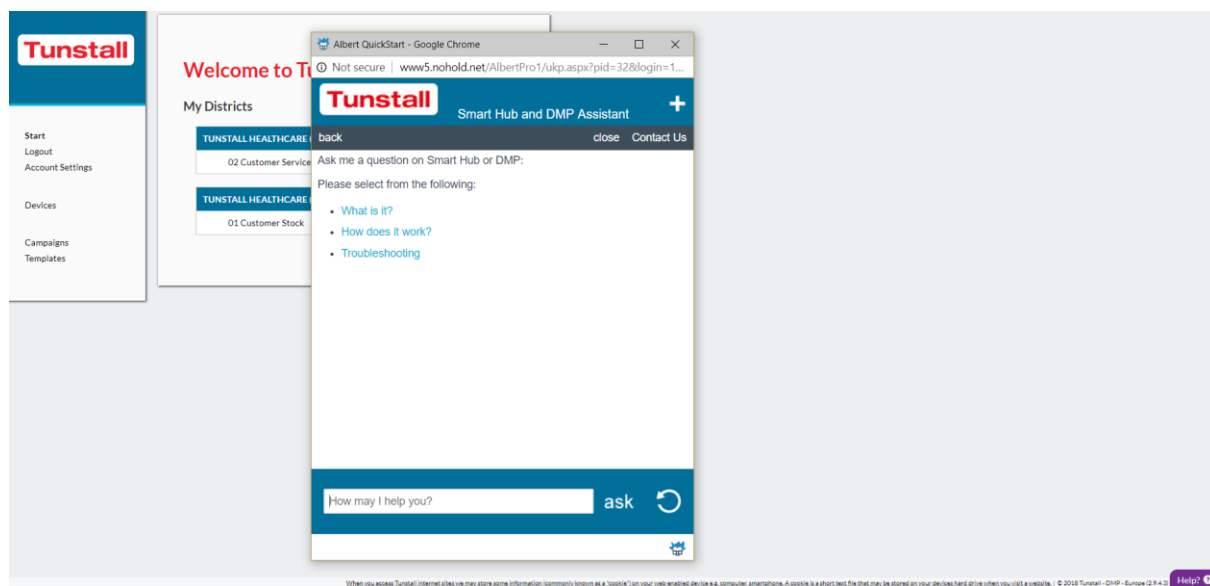

Enter the question you wish to ask in the field at the bottom of the pop-up and click the **ask** button. Information relating to your question will then appear in the main part of the pop-up, e.g., if you ask, “How do I add a pendant?”, the online help displays step-by-step instructions on how to add a pendant.

Alternatively, you can select from the options shown in the main part of the pop-up.

If you need to review information you have already seen, click the **back** button on the menu bar at the top of the pop-up. If you wish to clear your help and restart your search, click the  button.

When you have finished using the online help, click the **close** button on the menu bar to shut down the pop-up.

## F List of supported triggers/sensors

Note that availability of peripherals may vary by country and permitted radio frequency.

- Bath Sensor
- Bed/Chair Occupancy Sensor
- Bed In/Out
- Bogus Caller Trigger
- Carbon Monoxide Detector
- Door Contact Open/Closed
- Door Guard
- Enuresis Sensor
- Epilepsy Sensor
- Fall Detector
- Flood Detector
- Medication Dispenser
- Natural Gas Detector
- Personal Trigger
- PIR (Passive Infra-Red Movement Sensor)
- Pressure Mat
- Property Exit Sensor (virtual sensor comprising at least one PIR and one door contact sensor)
- Pull Cord
- ROM (Radio Output Module)
- Smoke Detector
- Ambient Temperature Sensor
- TX4 Pendant
- Universal Sensor.

## G List of typical default Smart Hub event settings

**Note: This section should be considered only as an example. Some default settings may be adapted by territory requirements and any templates which have been applied prior to installation.**

Key:

✓ means true/enabled

Clear means false/disabled

Event Type	Raise Alarm In Away	Raise Alarm In Home	Answer Incoming Call	Audible Reassurance	Visual Reassurance	Call Sequence Index	No. of Pre-alarm Announcements	Inactivity System Input	Enable Microphone On Alarm Call	Enable Speaker On Alarm Call	Alarm Mode	Relay Behaviour
Help Button (Alarm)	✓	✓		✓	✓	1	1	✓	✓	✓	Standard	None
Cancel Button			✓			1	0	✓			Standard	None
Away Button				✓	✓	1	1	✓	✓	✓	Standard	None
Inactivity Alarm		✓		✓	✓	1	1		✓	✓	Standard	None
Periodic Call (IP)					✓	9	1				Standard	None
Periodic Call (GSM)	✓	✓			✓	10	1				Standard	None
Mains Power Fail	✓	✓			✓	1	1				Standard	None
Mains Power					✓	1	1				Standard	None
System Battery Low	✓	✓			✓	1	1				Standard	None
Stuck Key	✓	✓			✓	1	1				Standard	None
Unit Failure	✓	✓			✓	1	1				Standard	None
Battery Charged					✓	1	1				Standard	None
Away State Entry					✓	1	1				Standard	None
Home State Entry					✓	1	1				Standard	None
IP Module Fail					✓	1	1				Standard	None
IP Connectivity Fail					✓	1	1				Standard	None
IP Connectivity Restore					✓	1	1				Standard	None
Failed To Contact the ARC						1	1				Standard	None
Personal Trigger Activation	✓	✓	✓	✓	✓	1	1	✓	✓	✓	Standard	None
TES - High Temperature	✓	✓		✓	✓	1	1		✓	✓	Standard	None
TES - Low Temperature	✓	✓		✓	✓	1	1		✓	✓	Standard	None
TES - Fault	✓	✓		✓	✓	1	1		✓	✓	Standard	None
TES - Temperature Rise	✓	✓		✓	✓	1	0		✓	✓	Standard	None
Flood Detector Activation	✓	✓		✓	✓	1	1		✓	✓	Standard	None

Event Type	Raise Alarm In Away	Raise Alarm In Home	Answer Incoming Call	Audible Reassurance	Visual Reassurance	Call Sequence Index	No. of Pre-alarm Announcements	Inactivity System Input	Enable Microphone On Alarm Call	Enable Speaker On Alarm Call	Alarm Mode	Relay Behaviour
CO Detector Activation	✓	✓		✓	✓	1	0		✓	✓	Standard	None
CO Detector EOL	✓	✓		✓	✓	1	1		✓	✓	Standard	None
CO Detector Fault	✓	✓		✓	✓	1	1		✓	✓	Standard	None
Smoke Detector Activation	✓	✓		✓	✓	1	0		✓	✓	Standard	None
Door Usage Opening				✓	✓	1	1	✓	✓	✓	Standard	None
Door Usage Closing				✓	✓	1	1	✓	✓	✓	Standard	None
Pressure Mat Activation				✓	✓	1	1	✓	✓	✓	Standard	None
Pullcord Activation	✓	✓		✓	✓	1	1	✓	✓	✓	Standard	None
Enuresis Activation	✓	✓		✓	✓	1	1		✓	✓	Standard	None
Bed or Chair Not In		✓		✓	✓	1	1		✓	✓	Standard	None
Bed or Chair Not Up		✓		✓	✓	1	1		✓	✓	Standard	None
Bed or Chair Absence	✓	✓		✓	✓	1	1		✓	✓	Standard	None
Bed or Chair Other	✓	✓		✓	✓	1	1		✓	✓	Standard	None
Fall Detector Button	✓	✓	✓	✓	✓	1	1	✓	✓	✓	Standard	None
Fall Detector Fall	✓	✓		✓	✓	1	1		✓	✓	Standard	None
Fall Detector Not Worn		✓		✓	✓	1	1		✓	✓	Standard	None
Fall Detector Activation Cancelled	✓	✓				1	1				Standard	None
PIR EE Activation				✓	✓	1	1	✓	✓	✓	Standard	None
PIR Non-EE Activation				✓	✓	1	1	✓	✓	✓	Standard	None
PIR Tamper				✓	✓	1	1		✓	✓	Standard	None
ROM1-4 Event 1-4	✓	✓		✓	✓	1	1		✓	✓	Standard	None
Natural Gas Detector Activation	✓	✓		✓	✓	1	0		✓	✓	Standard	None
PES Door Left Open	✓	✓		✓	✓	1	1		✓	✓	Standard	None
PES Client Wandered	✓	✓		✓	✓	1	1		✓	✓	Standard	None
Bogus Caller Activation	✓	✓		✓	✓	1	1	✓	✓		Standard	None
Medication Dispenser Dose Missed		✓		✓	✓	1	1		✓	✓	Standard	None
Medication Dispenser Device Fault	✓	✓		✓	✓	1	1		✓	✓	Standard	None
Medication Dispenser Dose Taken	✓	✓		✓	✓	1	1	✓	✓	✓	Standard	None
Bath High Level	✓	✓		✓	✓	1	1		✓	✓	Standard	None
Bath High Temperature	✓	✓		✓	✓	1	1		✓	✓	Standard	None
Bath Low Temperature	✓	✓		✓	✓	1	1		✓	✓	Standard	None
Epilepsy Sensor Activation	✓	✓		✓	✓	1	1		✓	✓	Standard	None
Epilepsy Sensor Other	✓	✓		✓	✓	1	1		✓	✓	Standard	None

Event Type	Raise Alarm In Away	Raise Alarm In Home	Answer Incoming Call	Audible Reassurance	Visual Reassurance	Call Sequence Index	No. of Pre-alarm Announcements	Inactivity System Input	Enable Microphone On Alarm Call	Enable Speaker On Alarm Call	Alarm Mode	Relay Behaviour
Auto Presence Failure	✓	✓			✓	1	1				Standard	None
Auto Presence Restore					✓	1	1				Standard	None
Auto Low Battery	✓	✓			✓	1	1				Standard	None
Radio Blocking					✓	1	1				Standard	None
Radio System Fault						1	1				Standard	None
Hardwired Input	✓	✓		✓	✓	1	1		✓	✓	Standard	None
Carer Arrived	✓	✓		✓	✓	1	1		✓	✓	Standard	None



# H Technical data

## H.1 Battery information

All batteries should be disposed of in accordance with the latest legislation.

## H.2 Technical details – Europe

Weight:	502g (1020g Packaged)
Dimensions:	185mm x 122mm x 41mm (WxLxD)
Mains power:	230v AC (3 Watts, typical)
Stand-by battery:	1200mAh (3G) or 2000mAh (4G) capacity (continually internally charged)
Back-up time:	24 hours of stand-by operation with one 30-minute alarm call (expected* at date of purchase and when fully charged)
Radio frequency:	869.2125MHz, compliant with the European Social Alarm frequency band 915MHz for Additional Sensors.
Radio trigger power:	The transmitted power in this band is less than 1mW e.r.p
External connections:	DC power adapter with 3m cable GSM antenna (internal or optional external) Ethernet Port USB Port (manufacturer use only)
Pendant battery:	3V Lithium (not changeable) with up to 7-year life
Cellular:	2G/3G 5 band GSM/GPRS/Edge/UMTS 2G/3G/4G 8 band GSM/SPRS/EDGE/UMTS/HSPA+/LTE

### Alarm Protocols

IP:	Tunstall IPACS, SCAIP
Tone:	Tunstall TT21 (STMF & DTMF), Tunstall TT92 (STMF & DTMF), BS8521 (DTMF)

### Environmental

Temperature:	Operating temperature (to perform to full specification) 0°C to 45°C
Storage:	10°C to 50°C
Humidity:	Operating humidity (to perform to full specification) 0 to 80% RH, non-condensing
Storage humidity:	0% to 93% RH, non-condensing

### Standards

EMC:	EN55032:2015, EN 55024:2010 +A1:2015, EN50130-4, EN301 489-1:V1.9.2, EN301 489-2:V1.6.1, EN301 489-7:V1.3.1
Safety:	EN60950
Radio:	EN300 220-2 Category 1
CE:	Compliant
Social alarm:	EN50134-1:2002, EN50134-2, EN50134-3:2012
Design, Manufacture, Installation and Service:	ISO9001:2008
ROHS Compliant:	Yes

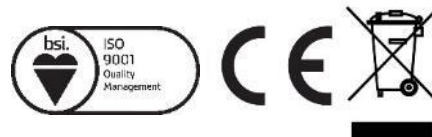

### Declaration of conformity

Tunstall declare that this radio equipment is in compliance with Directive 2014/53/EU.

The full text of the EU declaration of conformity is available at the following address: <http://www.tunstall.co.uk/approvals>

\* Time may be reduced by factors including temperature extremes, weak or intermittent cellular connectivity, high levels of sensor radio frequency activity and battery ageing.

## H.3 Technical details – Australia

Weight:	680g (1kg when packaged with personal radio trigger, power supply and accessories)
Dimensions:	185mm x 122mm x 41mm (WxLxD)
Mains power:	120V - 240V AC
Stand-by battery:	2000mAh capacity (continually internally charged)
Back-up time:	40 hours of stand-by operation (expected* at date of purchase and when fully charged)
Radio frequency:	917.6MHz & 927.8MHz (dual channel)
External connections:	DC power adapter with 3m cable GSM antenna (internal or optional external) Ethernet port USB port (manufacturer use only)
Pendant battery:	3V Lithium (changeable) with up to 5-year life
Cellular:	2G/3G GSM/GPRS/Edge/UMTS

### Alarm Protocols

IP:	Tunstall IPACS, SCAIP
Tone:	Tunstall TT21 (STMF & DTMF), Tunstall TT92 (STMF & DTMF), BS8521 (DTMF)

### Environmental

Temperature:	Operating temperature (to perform to full specification) = 0°C to 50°C Storage = -10°C to 55°C
Humidity:	Operating relative humidity (non-condensing to perform to full specification) = 0% to 90% Storage relative humidity (non-condensing) = 0% to 93%

### Standards

EMC:	AS/NZS CISPR 32:2013, AS/NZS 4252.1:1994
Safety:	AS/NZS 60950-1:2011
Radio:	AS/NZS 4268:2012 + A1:2013
PERS:	AS4607:1999
MEPS:	AS/NZS 4665-2005
Pendant:	IP67
Design manufacture:	ISO9001:2008
RoHS compliant:	2011/65/EU



\* Time may be reduced by factors including temperature extremes, weak or intermittent cellular connectivity, high levels of sensor radio frequency activity and battery ageing.

# I Glossary

Term/Acronym	Description
ALB	Auto Low Battery
AP	Auto Presence. Additional check that the trigger/sensor is functioning. When AP is enabled, each trigger/sensor sends an automatic test signal to the Smart Hub at a specified interval.
APN	Access Point Name. The name of a gateway between a GSM, General Packet Radio Service, 3G or 4G mobile network and another computer network, frequently the public internet.
ARC	Alarm Receiving Centre. Also referred to as the monitoring centre.
BS8521	A British Standards document that specified the Dual-Tone Multi-Frequency (DTMF) signalling protocol for social alarm systems.
CAT5	Category 5 cable. A twisted-pair cable for computer networks.
DC	Direct Current. A single direction flow of electrical charge.
DMP	Device Management Platform
DTMF	Dual-tone multi-frequency signalling. An in-band telecommunication signalling system using the voice-frequency band over telephone lines between telephone equipment and other communications devices and switching centres. Also known as tone dialling.
GPRS	General Packet Radio Service. A packet-oriented mobile data service on the 2G and 3G cellular communication systems' global system for mobile communications (GSM).
GSM	Global System for Mobile communications. A standard developed by the European Telecommunications Standards Institute (ETSI) to describe the protocols for digital cellular networks used by mobile devices.
Hrs	Hours
HTML	Hypertext Markup Language. The standard markup language for creating web pages and web applications. An option within DMP which provides a wider range of formatting options than text when creating emails, at a cost of increasing the email file size.
Hz	Hertz. A unit of frequency.
ID	Identifier

Term/Acronym	Description
IP	Internet Protocol. The communications protocol used for relaying data packets across network boundaries. Its routing function enables internetworking, and essentially establishes the internet.
IPACS	Independent Protocol for Alarm Communication Systems. Tunstall's IP protocol.
LED	Light-emitting diode
MHz	Megahertz
PC Connect	Programming tool used by other Tunstall Lifeline products.
PIN	Personal Identification Number. A numeric or alpha-numeric password or code used in the process of authenticating or identifying a user to a system and a system to a user.
PIR	Passive Infrared sensor. An electronic sensor that measures infrared light radiating from objects in its field of view, used in PIR-based motion detectors.
PNC	Piper Network Controller. Tunstall's ARC product.
PRC	Product Code. The long number printed on the label on the base of the unit. This unique identity is used when communicating with DMP, for stock item identification, and it also allows full product traceability.
QR Code	Quick Response Code. A type of matrix barcode (or two-dimensional barcode) that consists of black squares arranged in a square grid on a white background, which can be read by an imaging device such as a camera. The required data is extracted from patterns that are present in both horizontal and vertical components of the image. Used in two-step verification access to DMP.
RF	Radio Frequency
RSSI	Received Signal Strength Indicator. A measurement of the power present in a received radio signal.
SCAIP	Social Care Alarm Internet Protocol. An open IP protocol published by the Swedish Standards Institute. Used for handling multimedia communication streams, as well as sending event messages between the Alarm Sender and the Alarm Receiver, over an IP communication network such as the internet. The alarm protocol is defined as an XML schema including the alarm types, codes and additional information required to fulfil the requested functionality.
SIP	Session Initiation Protocol. A communications protocol for signalling and controlling multimedia communication sessions in applications of internet telephony for voice and video calls, in private IP telephone systems, as well as in instant messaging over IP networks.

Term/Acronym	Description
SMS	Short Message Service. A text messaging service component of most telephone, World Wide Web, and mobile device systems.
STMF	Sequential-tone multi-frequency signalling. Tunstall's alternative to DTMF, designed to provide improved reliability when communicating over cellular and VoIP connections.
TT21	A Tunstall tone protocol using DTMF or STMF signalling.
TT92	A Tunstall tone protocol using DTMF or STMF signalling.
URL	Uniform Resource Locator. Also known as a web address, is a reference to a web resource that specifies its location on a computer network and a mechanism for retrieving it.
VoIP	Voice over Internet Protocol. A methodology and group of technologies for the delivery of voice communications and multimedia sessions over Internet Protocol (IP) networks, such as the internet.
Wi-Fi	A technology for wireless local area networking with devices based on the IEEE 802.11 standards.

## J Contact details

### Australia

Tunstall Australasia  
Unit 1, 56 Lavarack Ave  
Eagle Farm  
Queensland 4009  
Australia

#### Mail address:

Locked Bag 1  
985 Kingsford Smith Drive  
Eagle Farm QLD 4009  
Australia

Tel: +61 7 3637 2200

Email: [info@tunstallhealthcare.com.au](mailto:info@tunstallhealthcare.com.au)  
Website: [www.tunstallhealthcare.com.au](http://www.tunstallhealthcare.com.au)  
Twitter: @TunstallAPAC

### Belgium

Tunstall N.V.  
Rusatiralaan 1  
1083 Brussels  
Belgium

Tel +32 2 51 000 70

Email: [info@tunstall.be](mailto:info@tunstall.be)  
Website: [www.tunstall.be](http://www.tunstall.be)  
Twitter: @tunstallbenelux

### Canada

Tunstall Canada Inc.  
111 Zenway Blvd  
Unit 6A  
Woodbridge  
Ontario L4H 3H9  
Canada

Tel: +1 905 677 1144

Email: [sales@tunstallamerica.com](mailto:sales@tunstallamerica.com)  
Website: [www.canada.tunstall.com](http://www.canada.tunstall.com)  
Twitter: @TunstallAmerica

### Denmark

Tunstall A/S  
Niels Bohrs Vej 42  
Stilling  
8660 Skanderborg  
Denmark

Tel: +45 87 93 50 00

Email: [info@tunstallnordic.com](mailto:info@tunstallnordic.com)  
Website: [www.tunstallnordic.com](http://www.tunstallnordic.com)  
Twitter: @TunstallNordic

### Finland

Tunstall Oy  
Äyritie 22  
01510 Vantaa  
Finland

Tel: +358 10 320 1690

Email: [info@tunstallnordic.com](mailto:info@tunstallnordic.com)  
Website: [www.tunstallnordic.com](http://www.tunstallnordic.com)  
Twitter: @TunstallNordic

### France

Pantin manufacture Bat C3  
140 Avenue Jean Lolive  
93500 Pantin  
FRANCE

Tel: +33 810 00 55 63

Email: [contact@tunstall.fr](mailto:contact@tunstall.fr)  
Website: [www.tunstall.fr](http://www.tunstall.fr)

### Germany

Tunstall GmbH  
Orkotten 66  
48291 Telgte

Tel: +49 2504 701-0

Email: [info@tunstall.de](mailto:info@tunstall.de)  
Website: [www.tunstall.de](http://www.tunstall.de)  
Twitter: @TunstallGmbH

### Malta

emCare Group Malta Limited  
6PM Business Centre  
Triq it-Torri  
Swatar  
BKR 4012

Tel: +356 2142 4949

### New Zealand

Tunstall New Zealand  
306 Cameron Road  
Tauranga

#### Mail Address:

PO Box 13153  
Tauranga  
New Zealand

Tel: +64 (0)7 517 2685

Email: [info@tunstall.co.nz](mailto:info@tunstall.co.nz)  
Website: [www.tunstall.co.nz](http://www.tunstall.co.nz)  
Twitter: @TunstallAPAC

**Norway**

Vakt og Alarm AS  
Guard and Alarm AS  
Etne Village Center  
5590 Etne  
Norway

Tel: +47 53771001

Email: [lillian@vaktogalarm.no](mailto:lillian@vaktogalarm.no)  
Website: [www.vaktogalarm.no](http://www.vaktogalarm.no)

**Spain**

Tunstall Televida  
Avda. de Castilla  
2 Parque Empresarial San Fernando  
Edificio Munich  
2ª Planta  
28830 San Fernando de Henares  
Madrid  
Spain

Tel: +34 91 655 58 30

Email: [teleasistencia@televida.es](mailto:teleasistencia@televida.es)  
Website: [www.tunstalltelevida.es](http://www.tunstalltelevida.es)  
Twitter: @TunstallTlevida

**Sweden**

Tunstall AB  
Agnesfridsvägen 113 A  
Box 9028  
SE-200 39 Malmö  
Sweden

Tel: +46 40 625 25 00

Email: [info@tunstallnordic.com](mailto:info@tunstallnordic.com)  
Website: [www.tunstallnordic.com](http://www.tunstallnordic.com)  
Twitter: @TunstallSverige

**Switzerland**

Tunstall AG  
Atte Lyssstrasse 1  
3270 Aarberg  
Switzerland

Tel: +41 264 93 43 46

Email: [s.beyeler@tunstall.ch](mailto:s.beyeler@tunstall.ch)  
Website: [www.tunstall.ch](http://www.tunstall.ch)

**The Netherlands**

Tunstall B.V.  
Oslo 28  
2990 AH Barendrecht  
The Netherlands

Tel: +31 180 696 696

Email: [info@tunstall.nl](mailto:info@tunstall.nl)  
Website: [www.tunstall.nl](http://www.tunstall.nl)  
Twitter: @TunstallNederland

**United Kingdom**

Tunstall Healthcare (UK) Ltd  
Whitley Lodge  
Whitley Bridge  
Yorkshire  
DN14 0HR  
United Kingdom

Tel: +44 1977 661234

Email: [enquiries@tunstall.com](mailto:enquiries@tunstall.com)  
Website: [www.uk.tunstall.com](http://www.uk.tunstall.com)  
Twitter: @TunstallHealth

**United Kingdom**

Tunstall Response  
Ascot House  
Unit 1  
Malton Way  
Adwick le Street  
Doncaster DN6 7FE  
United Kingdom

Tel: 08450 565456

Email: [enquiries@tunstallresponse.co.uk](mailto:enquiries@tunstallresponse.co.uk)  
Website: [www.uk.tunstall.com/monitoring](http://www.uk.tunstall.com/monitoring)

Our policy of continual development means that product specification and appearance may change without notice. Tunstall does not accept any responsibility for any errors or omissions contained in this document.

© 2021 Tunstall Group Ltd. ® TUNSTALL and LIFELINE are registered trademarks.

Tunstall Group Limited, Whitley Lodge, Whitley Bridge, Yorkshire DN14 0HR