

Domestic Loop System (DLS)



Induction loop system for use with Tunstall Lifeline Connect+ and Communicall Connect Speech Module

This manual is a detailed guide for the installation and adjustment of the Ampetronic DLS when used with the Tunstall Lifeline Connect+ or Communicall Connect Speech Module Systems

- IMPORTANT SAFETY INSTRUCTIONS..... 2**
- WARRANTY..... 2**
- DECLARATION OF CONFORMITY..... 3**
- 1 THE AMPETRONIC DLS AMPLIFIER..... 4**
- 2. DLS COMPONENTS 5**
- 3. BEFORE INSTALLING..... 6**
- 4. INSTALLING THE AMPLIFIER..... 6**
- 5. FITTING THE UNIVERSAL ADAPTER..... 7**
- 6. INSTALLING THE LOOP..... 7**
- 7. CONNECTING SOUND SOURCES..... 9**
- 8. SETTING UP FOR FIRST USE..... 10**
- 9. TROUBLESHOOTING..... 12**
- 10. SYSTEM SPECIFICATION..... 13**

IMPORTANT SAFETY INSTRUCTIONS

1. Read these instructions.
2. Keep these instructions for future reference.
3. Heed all warnings.
4. It is important to follow all instructions.
5. Do not use this equipment near to water.
6. Clean only with a dry cloth.
7. Do not place objects filled with water such as a vase near or on the equipment.
8. Do not install the DLS amplifier near to sources of heat such as radiators, stoves or other equipment producing heat.
9. Do not place the DLS amplifier in a fully enclosed space; ensure that the amplifier has ventilation when in use.
10. This equipment is designed only for servicing by qualified personnel. Servicing is required when the apparatus has been damaged or exposed to rain or moisture, or has been dropped.

WARRANTY

This product carries a one year parts and labour guarantee which may be invalidated if instructions are not followed correctly or if the unit is misused or used for an unintended purpose.

Refer all enquiries relating to the product guarantees to your reseller or distributor.

DECLARATION OF CONFORMITY

DLS Amplifier

Manufacturer: Ampetronic Ltd.
Northern Road, Newark, NG24 2ET. United Kingdom.

Declares that: Domestic Loop Amplifier.

Type name: DLS.

Conforms to the following directives and norms:

Directive 2004 / 108 / EC EMC directive.

- EN61000-6-1:2007 Immunity.

- EN61000-6-3:2007 Emissions.

Directive 2006 / 95 / EC The low voltage directive.

- EN60065:2002.

November 2007

Leon Pieters, Technical Director

Ampetronic Ltd.

Universal Adapter

Manufacturer: Ampetronic Ltd.
Northern Road, Newark, NG24 2ET. United Kingdom.

Declares that: Telephone isolation unit.

Type name: Universal Adapter.

Conforms to the following directives and norms:

Directive 2004 / 108 / EC EMC directive.

- EN61000-6-1:2007 Immunity.

- EN61000-6-3:2007 Emissions.

Directive 2006 / 95 / EC The low voltage directive.

- EN60950:2006.

July 2008

Leon Pieters, Technical Director

Ampetronic Ltd.

1. THE AMPETRONIC DLS AMPLIFIER

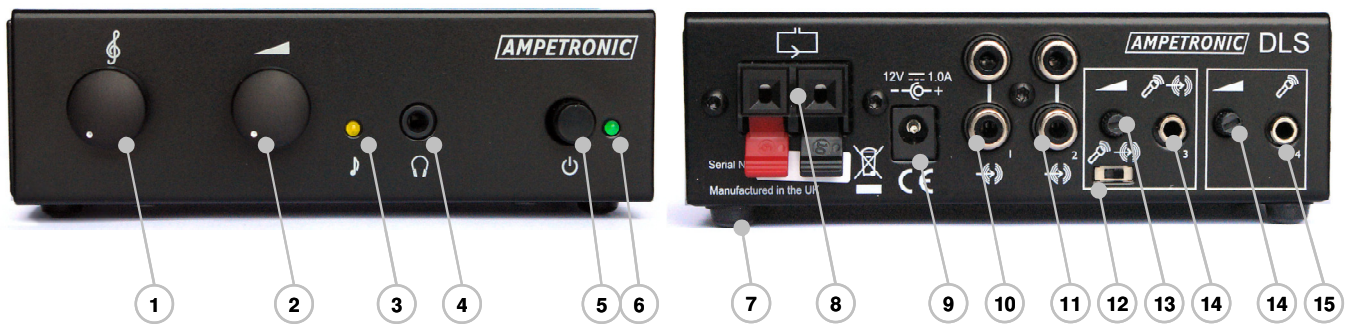

Fig 1

DESCRIPTION

FEATURE

1.	TONE CONTROL	Tone control, normal response with knob at centre and marker pointing up. Adjust to give your preferred sound.
2.	VOLUME CONTROL	To adjust volume transmitted by the loop.
3.	SIGNAL INDICATOR	When lit, the input level is high enough to ensure that the loop will be loud enough. Normally on when sound is present.
4.	HEADPHONE SOCKET	Monitors the signal that is actually broadcast into the loop. Useful for setting up the loop and fault finding.
5.	POWER SWITCH	To turn power on and off. The Ampetronic DLS can be left on at all times, or turned off when not used as preferred.
6.	POWER INDICATOR	Green light, on when the unit has power and is turned on.
7.	RUBBER FEET	To isolate the unit from vibration and heat and provide a secure and stable base in any installation.
8.	LOOP CONNECTOR	Speaker style connector for the two cable ends of the loop.
9.	POWER CONNECTOR	Power connector for the 12V DC power supply provided.
10.	INPUT 1	Audio input with phono connectors (see section 7).
11.	INPUT 2	Audio input with phono connectors (see section 7).
12.	INPUT 3 (ALERT) SWITCH	Selects line level (right) or microphone (left) for input 3. Select LINE position for Tunstall equipment.
13.	INPUT 3 (ALERT) LEVEL ADJUSTER	Adjusts sensitivity of input 3, setting the level at which a noise will trigger the alert (priority) input. Set to maximum clockwise position for Tunstall equipment.
13.	INPUT 3 (ALERT)	Alert input – sounds at this input will override other inputs, and be turned off when not in use. Tunstall Equipment must be connected here.
14.	INPUT 4 LEVEL ADJUSTER	Adjusts sensitivity of microphone input 4 as required.
15.	INPUT 4 (MICROPHONE)	Microphone input for electret style microphone (provided) with minijack input.

2. DLS COMPONENTS

The DLS kit contents:

- DLS amplifier and instructions (1)
- 33m loop cable and cable clips (2)
- 1 x Clip microphone and cable (3)
- 1 x Mini-jack to phono cable (4)
- 1 x phono cables (5)
- 1 x power supply (6)

Universal Adapter Kit

- 1 x Universal Tele adapter (7)
- 1x Cable A (RJ11 – RJ45)
- 1x Cable B (RJ11 – JST PA 0.1)
- 1 x Cable C (Audio 3.5mm Jack)

Additional accessories

Available through your local dealer.

- Chair pad (8)
A 40cm square pad to place under or in a cushion on a chair or sofa, to create a local field for one person, often instead of using the room loop cable.
- SCART adapter (9)
To connect a television to the amplifier using a 'through-SCART' connection that does not affect your existing SCART connections.
- Additional cables and microphones.

(1)



(2)

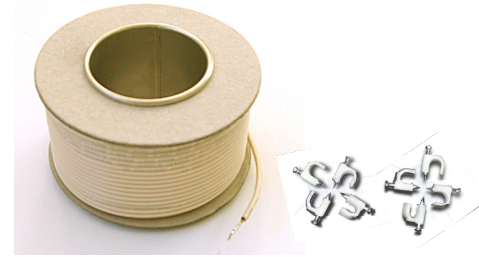

(3)



(4)



(5)



(6)



(7) Universal Adapter



Cables not shown

(8)

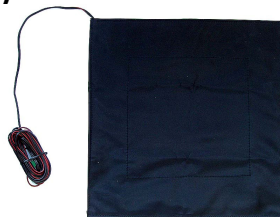

(9)

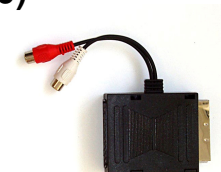

Fig 2

3. BEFORE INSTALLING

Before the DLS system is installed please check that the environment is suitable.

Background noise

Occasionally poor quality electrical systems can create interference. Before installing the DLS, use a receiver such as the ILR3+ to listen to the background magnetic noise or measure it using the Ampetronic Field Strength Meter (FSM). If the background magnetic noise is too high, (greater than -22dB, A weighted) the system should not be installed. If the background magnetic noise is greater than -32dB the customer should be consulted.

Other loop systems

The DLS loop system will create a strong signal within the area of the loop. There is also a much weaker signal that carries up to 3 times the width of the loop away from where the loop is installed. This can occasionally cause a problem if:

- there is another 'room loop' induction loop system in use within this distance – in which case, there may be crosstalk between the two systems.
- the system is used for confidential or private conversations with microphones or the telephone.

If these issues are anticipated then a chair pad can be installed instead of a room loop. See Chair Loop Installation instructions.

4. INSTALLING THE AMPLIFIER

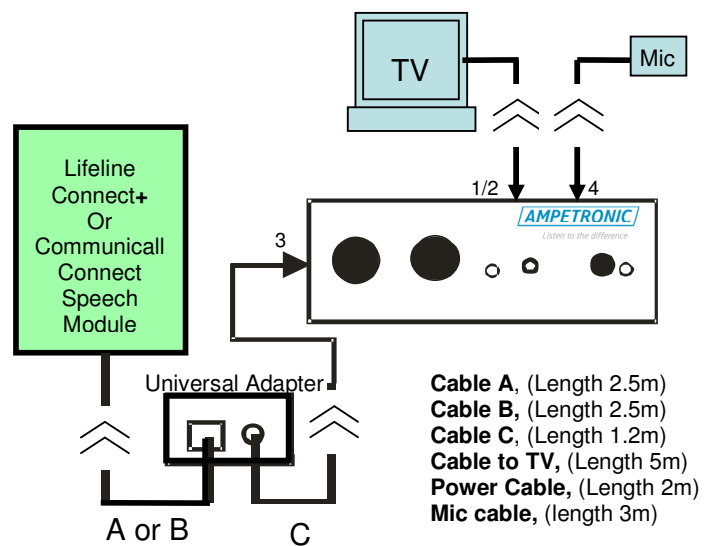

Fig 3

Where to position the DLS amplifier?

The DLS amplifier should be placed in an accessible location and within a suitable distance (see cable lengths above) from:

- the Universal Adapter.
- the sound sources to be connected e.g. TV.
- the Lifeline Connect+ or Speech Module.
- the microphone (if used).
- 240V AC power outlet for DLS.
- 240v AC power outlet for Connect+.

This location must be dry and well ventilated.

The DLS amplifier must not be covered.

Installing the amplifier

Having found a suitable location, set the amplifier in position either free standing or wall / panel mounted – see below for wall / panel mounting instructions.

Wall / panel mounting

Included in the DLS amplifier box is a template for marking out the two screw holes.

Decide on the location for the DLS amplifier and use the template to mark out two screw holes. Put two screws in place (screw heads should be 6-8mm diameter). Leave the screw heads protruding by 8-10mm from the wall. Hang the DLS amplifier on the screw heads using the holes on the bottom of the case.



Fig 4

5. FITTING THE UNIVERSAL ADAPTER

The Universal Adapter must be used to interface the DLS to the Lifeline Connect+ or Speech Module with the cables provided.

It can be fixed in place with an adhesive pad or by using the fixing holes as shown

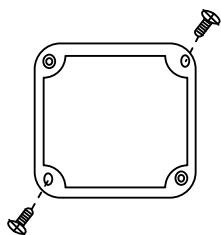

Fig 5

The Universal Adapter can be mounted to a wall or other surface using two No.6 screws (3.5mm). Fixing dimensions are given on the rear of the Adapter box.

Unscrew the two pozi screws on the front of the Adapter and remove the front cover. Do not touch any of the internal components. Secure the Adapter using the two No.6 screws (not supplied) and re-fit the cover.

6. INSTALLING THE LOOP

Room loop installation

Provides optimum coverage for listening when moving, standing up or in different locations within the room.

A room loop is a loop of wire usually placed around the wall or skirting board.

A wire can also be used around a smaller area underneath carpet or a rug. The loop must cover the whole area in which the user needs to hear the sound from the DLS induction loop.

A room loop is simple to install and can be fixed in place using the cable clips provided, or other fixing method.

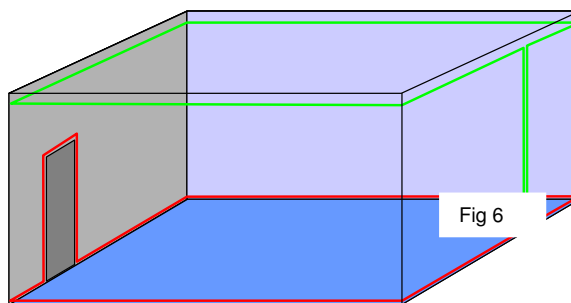

- Decide what the area is that needs to be covered by the cable.
- Start with one end of the cable at the DLS amplifier.
- Run the cable from the cable reel provided around the edge of the area that is to be covered. Typically this will be the edge of a room.
- Use cable clips (provided) to secure the loop cable, or place the loop cable underneath a rug or carpet.
- The cable should ideally be fitted at floor or ceiling level, never at head height. Fig 6 shows both options as a green and a red loop.

- Cable can run over doorways to prevent trip hazards, see the red loop in the diagram.
- Run the free end of the cable back to the DLS amplifier.
- Cut the cable to length. This must be at least 8m long for the system to operate.
- Connect the cable ends to the amplifier. See Connecting the Loop to the Amplifier.
- The room loop is now installed.

Chair loop installation

The Chair Loop pad is an optional accessory. It is supplied with 5m of detachable cable for easy installation.

Make sure that the pad can be placed under or behind the chair to be used and the cable can be run safely from the chair to the DLS amplifier.

- Place the pad in one of three places: under the seat cushion; behind the seat back; or inside a seat cushion (seat or backrest).

Run the connecting cables to the DLS amplifier.

- Cover the cable with a rug or other protection to prevent tripping or catching the cable.



Fig 7

- Connect both ends of the loop cable to the DLS amplifier. See Connecting the Loop to the Amplifier.
- The chair loop is now installed.

Connecting the loop to the amplifier

Once the loop has been installed the two cable ends must be connected to the loop connector on the DLS amplifier (shown below).

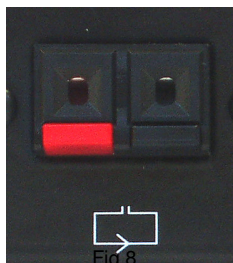

Fig 8

First, terminate the cable ends if required so both cable ends have 5-15mm of exposed cable:

The connector has two holes above a red and a black switch. When the switches are pushed down the hole is open, when the switch is pushed up the hole is closed and the loop cable will be clamped in place.

Connect one end of the cable to the black terminal of the DLS amplifier:

- Push the black terminal of the loop connector down.
- Put the cable end into the hole above the black switch.
- Lift up the black switch to capture the cable in place.

Connect the free end of the cable to the red terminal of the DLS amplifier in the same way.

Check that both loop wires are securely held by the connector on the DLS amplifier.

7. CONNECTING SOUND SOURCES

The Ampetronic DLS can accept up to 3 additional inputs simultaneously with the Lifeline Connect+ or Speech Module.

Inputs 1 and 2 (line inputs)

Up to two of the following items can be connected:

- Television
- HiFi
- Radio
- Computer audio
- iPod / MP3 player

- Select the appropriate cable for the equipment, minijack, phono or SCART (optional accessory).
- Connect the two phono jacks to the connectors of input 1 or input 2 and the other end to the equipment.

Input 3 (alert input)

- This input is reserved for the **Lifeline Connect+** or the **Speech Module**. It is a priority input. If a signal is present on this input all other signals will be turned down.
- Locate the switch on input 3 on the rear of the DLS amplifier and make sure that it is in the line input position.
- The Tunstall system is connected to the DLS unit through the Universal Adapter.
- To connect the **Lifeline Connect+**, cables A and C are used with the Universal Adapter.

- Connect the RJ45 and the two loose wires of Cable A to the **Lifeline Connect+** as shown below:

Note. These wires are not polarity conscious.



- To connect the **Speech Module**, cables B and C are used with the Universal Adapter

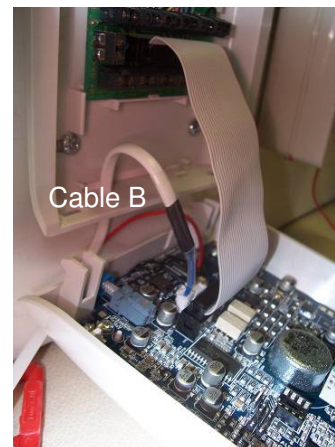

Fig 9

Input 4 (microphone input)

This input will accept one microphone. The microphone can be used for:

- Room sounds, e.g. speech
- Television or other loudspeaker
- Mount the microphone so that it can pick up the desired sounds. Use the adhesive pad to attach to the loudspeakers or any other surface.
- Connect the microphone jack to input 4 of the DLS amplifier.

8. SETTING UP FOR FIRST USE

Although not essential, it is recommended that the field strength of the system is set up to the IEC standard level used for hearing aids.

Set the controls for inputs 3 and 4 and the volume control to minimum. Set the tone control to the mid position.

Plug the unit into power using the power cord, and turn the unit on at the front panel switch. The green light should come on when there is power. The yellow light (3) will glow for a few seconds and go off. This is normal.

- **TO SET UP FIELD STRENGTH using the field strength meter.**

Tools

- Field strength meter (FSM).
- MP3 or CD player with headphone output.
- Cable 4 (supplied).
- Test signal:
 - Pink noise with 1 kHz tone.
- Tippex or other semi-permanent marker.

Method

Connect the audio player to input 1 and play test signal 1. The yellow light 3 should illuminate and stay lit. If not, turn up the volume of the audio player until the light comes on. (The compression circuit of the DLS is now active).

With the field strength meter turned on and switched to 'Field Strength', measure the field strength at the **typical listening position of the user, at head height** (Possibly a favourite armchair). Now adjust the volume control on the DLS until the meter reading jumps between

readings of -6dB (pink noise playing) and 0dB. (1 kHz sine wave bursts). The field strength is now set to the IEC60118-4 standard. Mark the position of the volume control with tippex or other suitable semi-permanent marker. **DO NOT MAKE ANY FURTHER ADJUSTMENTS TO THIS CONTROL.**

Disconnect the player and connect the required source(s), TV, HiFi etc., to inputs 1 and 2.

- **TO SET UP FIELD STRENGTH Using the ILR3+ loop listener**

Tools

- ILR3+.
- MP3 or CD player with headphone output.
- Cable 4 (supplied).
- Test signal: Pink noise.
- Tippex or other semi-permanent marker.

Method

Connect the audio player to input 1 and play the test track. The yellow light (3) should illuminate and stay lit. If not, turn up the volume of the audio player until the light comes on. (The compression circuit of the DLS is now active).

With the ILR3+ turned on and volume setting as required, observe the field strength at the **typical listening position of the user, at head height** (Possibly a favourite armchair). Now adjust the volume control on the DLS until the green and amber LED's on the ILR3+ flicker (See ILR3+ user instructions).

Note: ILR3 and ILR3+ audio induction loop receivers are available from www.ampetronic.com.

The field strength is now set approximately to the IEC60118-4 standard. Mark the position of the volume control with Tippex or other suitable semi-permanent marker. **DO NOT MAKE ANY FURTHER ADJUSTMENTS TO THIS CONTROL.**

Disconnect the player and connect the required source(s), TV, HiFi etc., to inputs 1 and 2.

- **SET UP INPUTS 1 & 2**

Using inputs 1 or 2 turn on one of the connected sound sources and make sure that it is producing sound.

The yellow light should come on permanently or intermittently. If not, then the input is too quiet. Change the programme material or turn up the input level until the yellow light comes on.

- **LISTEN AND SET VOLUME & TONE**

Set up your receiver, FSM or ILR3+ to receive the loop signal.

Listen to the system in the normal listening position, holding the receiver at head height. The volume should be OK (This was set to standard in the previous section). Adjust the tone control to suit.

To set up input 2, repeat the process above. Make sure that there are no other input signals present.

- **SET UP ALERT INPUT 3**

Input 1 or 2 must be connected and running with a continuous sound.

- **SPEECH MODULE**

Ensure Input 3 level adjuster on DLS is in the maximum position and ensure the switch is in the Line position.

Using the Ampetronic ILR3+ receiver or FSM, with headphones, listen to the source material playing on input 1 or 2.

Warn the warden not to answer a call during testing. Press the red button on the Speech Module and monitor the beeps. The signal on input 1 or 2, as selected, should reduce and the beep should be clearly audible.

- **LIFELINE CONNECT+**

Ensure Input 3 level adjuster on DLS is in the maximum position and ensure the switch is in the Line position.

Using the Ampetronic ILR3+ receiver or FSM, with headphones, listen to the source material playing on input 1 or 2. **REMOVE THE TELEPHONE LINE FROM THE LIFELINE CONNECT+.**

Press the yellow button on the Lifeline Connect+ and monitor the Home/Away message beeps. The signal on input 1 or 2, as selected, should reduce and the messages should be clearly audible. Press the green CANCEL key several times to cancel any alarms and then **REPLACE THE TELEPHONE LINE.**

- **SET UP INPUT 4**

Test the level of the microphone input (input 4) if used. Adjust the microphone level on the back panel, if required, so the microphone volume is balanced with the other sound sources.

- **ADJUSTMENTS IN NORMAL DAY TO DAY USE**

The amplifier is now set correctly. Gain is automatically controlled so you should hear the right volume level whatever you are listening to and you should not need to make any further adjustments.

9. TROUBLESHOOTING

The Ampetronic DLS should not require any maintenance or support. In the event that you have problems, please consult the list of possible problems below before contacting your supplier.

1. No sound / low volume

- Check that the power light (green) is on to confirm that the unit has power.
- Check that there is a sound being produced by the input source.
- With an input source making a sound, the front panel yellow light should come on permanently or intermittently. If not your input level is too low.
- Check that there is a signal in the loop using headphones in the headphone jack on the front panel – if not then there is a problem with the loop or there is no input signal.
- Check the loop connections – are both loop ends connected firmly and the cable ends are properly terminated with exposed wire in the contacts?

2. Interference / hum / background noise in the loop

- Check the hearing aids / receivers are set correctly.
- Turn the loop system off and check to see if background noise remains. If it does then the noise may be created by other electrical systems. Try turning off nearby appliances to find the source of interference. Noise may also come from another nearby loop system – are there any other loop systems within 10m of your system?
- If a microphone is connected to input 4, turn the level control down or disconnect the microphone – does the background noise remain? If not, reduce the noise being picked up by the microphone or reduce the gain control on input 4.

3. Alert input not working

- Check the connections between the Lifeline Connect+ or Speech Module, and Universal Adapter and DLS
- Make sure that the volume of the alert signal is high – Increase the output level if possible

10. SYSTEM SPECIFICATION

DLS Specification

Inputs:

 1 & 2. Four input Line level phono connector, fixed gain, allowing two stereo inputs.

 3. One independent mic/line input; Priority Microphone/Line control which is switchable between Mic or Line level. VOX switching is permanently enabled on this channel.

 4. One independent Mic input, gain control – rear panel, allowing adjustment to the correct level.

DC Power input, 2.1mm, centre positive.

Controls:

 Tone control: Independent front panel control allowing frequency response adjustment for differing installation variations.

 Loop volume: Independent front panel control allowing Loop output current (volume) adjustment.

Microphone input 4 gain control – rear panel.

Mic / Line input 3 gain control – rear panel.

Input specifications:

Microphone input 4:

Connector: 3.5mm mono jack socket.

One independent microphone input suitable for use with an unbalanced electret microphone.

Input impedance: 8k Ω .

Phantom voltage: 6V via 10k Ω source.

Input sensitivity: -60dBu for maximum output

Switchable Line / Mic input 3:

Line input selected:

Connector: 3.5mm mono jack socket.

Slide switch selection.

Input impedance: 820k Ω .

Input sensitivity: Line input selected: -20dBu for maximum output after VOX enabled at -12dBu

Microphone input selected:

Levels as per microphone input 4. VOX enabled at -53 dBu.

Line level inputs 1 and 2:

4-way phono input connector. Fixed gain.

Input sensitivity: -10dBu for maximum output.

Overload: >30dBu

Compression:

Compression Dynamic range: >36dB before overload. (Typically 40dB).

Compression indication via amber signal LED.

Efficiency: ± 1 dB across 40dB dynamic range.

Attack and decay times optimised for speech.

Attack time: Less than 5ms; Decay time: Less than 2 seconds.

Frequency response:

80 Hz to 6.3 kHz ± 1.5 dB into 1 Ω load at low level, measured as loop current with no Metal Loss correction.

Tone control:

A modified tone control allowing a flat response or bass boost / HF cut or HF boost / bass cut, with additional HF boost to allow compensation for distortion due to metal structures in surrounding buildings.

Outputs

Headphone monitoring output via front panel with stereo 3.5mm jack.

Output connection: Loop, finger operated quick connect output connector.

Current: >2.4A_{RMS} into 1 Ω .

Voltage: >3.2V_{RMS}.

Loop resistance: 0.3 Ω to 1.0 Ω resistive or 1.5 Ω maximum reactive impedance at 1.6 kHz.

Connection: Finger operated speaker type connector.

Area coverage:

>30m² coverage to requirements of IEC60118-4, or use with supplied special loop pad.

Note that the amplifier can drive loops far in excess of this size if the full performance of IEC60118-4 is not required by the end user.

Environmental:

Ambient temperature: -10 $^{\circ}$ C to 45 $^{\circ}$ C.

Relative humidity: 20% to 90%

IP rating: IP20

Ventilation: Ensure adequate ventilation is provided for the Domestic unit as the unit becomes warm during operation.

Mounting: Unit may be mounted horizontally or vertically. Rubber 'bump on' feet are fitted allowing free standing.

Two screw slot fittings allowing wall mounting of the unit are incorporated.

Physical:

Weight: 305g.

Length: 133mm.

Width: 72mm.

Height: 40mm

Power requirements:

12V DC @ 1.0A max.

Fuse fitted to PCB, type T 1.6A L

Green LED Power indicator.

AC Power adapter (Powerpax 85-2943):

Input: 100Vac – 240Vav 47 - 63Hz.

Power consumption: Standard load = 10W (1.0A_{RMS} pink noise output, as per IEC60065).

Power consumption: Quiescent = 1.0W.

Output: 12Vdc at 1.25A max.

AC Power adapter UK (Powerpax 85-2915):

Input 230Vac, 45 – 65 Hz.

Power consumption: standard load = 10W (1.0A_{RMS} pink noise output, as per IEC60065).

Power consumption: Quiescent = 2.0W.

Output: 12Vdc at 1.0A max.

Note: Above 85-2915 PSU may change to SMPSU plugtop type, PowerPax SW3525. 12V, 1.25A.

Universal Adapter Specification

Direct throughput:

Input impedance: $>10\text{k}\Omega$ @ 1kHz.

Output impedance: $5\text{k}\Omega$.

Gain = -6 dB.

Overload: 5V RMS @ 1 kHz.

Frequency response: 100Hz to 20kHz, -3dB.

Buffer amplifier enabled:

Input impedance: $> 1\text{ M}\Omega + 120\text{pF}$.

Output impedance: $1\text{k}\Omega$.

Gain = 5 dB.

Current consumption @ 12V DC input: 20mA.

Overload: 1.5V RMS @ 1 kHz.

Frequency response: 50Hz to 20kHz, -3dB.

General:

Distortion: $<0.5\%$ THD+N at -10dBu (245mV input).

Weight: 71g.

Dimensions: 65mm x 50mm x 35.5mm.

Ambient temperature: 0°C to 35°C .

Relative humidity: 20% to 90%

IP rating: IP30

Page intentionally left blank

AMPETRONIC

Listen to the difference

Manufactured by Ampetronic Ltd.

**Ampetronic
Northern Road
Newark
NG24 2ET
United Kingdom**

**+44 (0) 1636 610062 telephone
+44 (0) 1636 610063 fax
www.ampetronic.com**

Supplied by:

Tunstall Group Ltd

Whitley Lodge, Whitley Bridge

Yorkshire

DN14 0HR

www.tunstallhealth.com

Tel: 01977 661234

Fax: 01977 662450

Email: enquiries@tunstall.co.uk

Contact your supplier for questions and support