

Installation and programming guide



Lifeline Connect and Connect+

Contents

Installation Guide	3
What's in the box	3
Your home unit	4
For your safety - Installation advice	4
Quick start guide	6
Using the home unit	8
Making an alarm call	8
Cancelling an alarm call	8
Answering calls remotely via the personal trigger	8
Status warnings	9
Telephone line monitoring	9
Power failure monitoring.....	9
The lights on the home unit indicate	10
The LED on the personal radio trigger indicates	10
Programming a telecare sensor to the home unit	11
Range Test	11
Programming guide	12
How to program via PC Connect programming software	14
How to program via PNC software	14
PNC5 or 6.....	14
PNC4.....	14
How to program using a series telephone	14
Frequently used series telephone codes	15
Quick Codes	18
Features at a glance	20
Features explained	22
Telephone numbers & IDs.....	22
Call sequences	22
Away button options.....	22
Radio triggers	22
Periodic calls.....	22
Backup battery monitoring.....	23
Intruder monitoring.....	24
Event configuration	24
Hardwired input.....	25
Fault monitoring	25
Speech configuration	25
Inactivity monitoring	26
Personal recipient messages	27
Recordable personal recipient messages (Lifeline Connect+ only).....	27
Hardwired output (Lifeline Connect+ only)	28
Reminder functionality (Lifeline Connect+ only)	28
Critical visits (Lifeline Connect+ only)	30
Auto Answer (Lifeline Connect+ only).....	30
Keyless entry (Lifeline Connect+ only).....	30
Alarm control by time (Lifeline Connect+ only).....	30
Virtual Sensors (Lifeline Connect+ only)	31
ADLife (Lifeline Connect+ only)	32
Table 1 – TT92 Codes	36
Table 2 - TT21 Location Codes	37
Table 3 - Trigger Type Codes	37
Table 4 - TT21 Call Codes	38
Technical Details	40
Environmental	40
Standards	40
Declaration of Conformity	40

Installation Guide

What's in the box

When you open the box for the first time, please ensure you have all of the following:

Home unit



Personal radio trigger
MyAmie

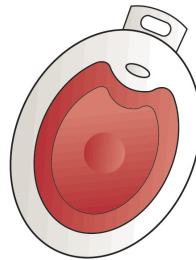

Personal radio trigger wearing options

Neckcord

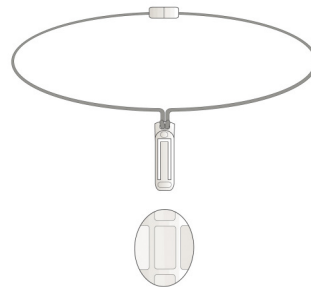

Wrist strap



Leads and adaptors

Ⓐ Telephone lead (3 metre cable)



Ⓑ Telephone adaptor



Ⓒ Mains adaptor (3 metre cable)



Installation and User Guide

If any of the above items are missing, please contact your supplier.

Your home unit

Front view

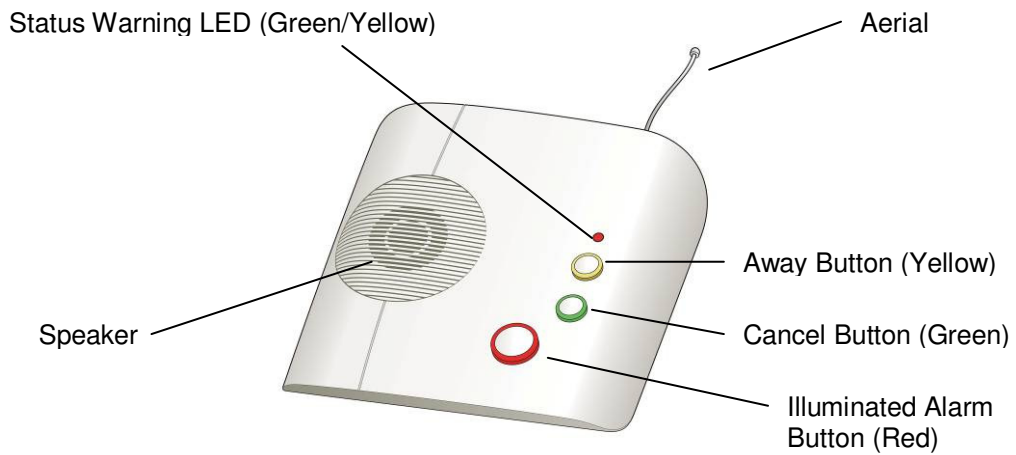

Back view

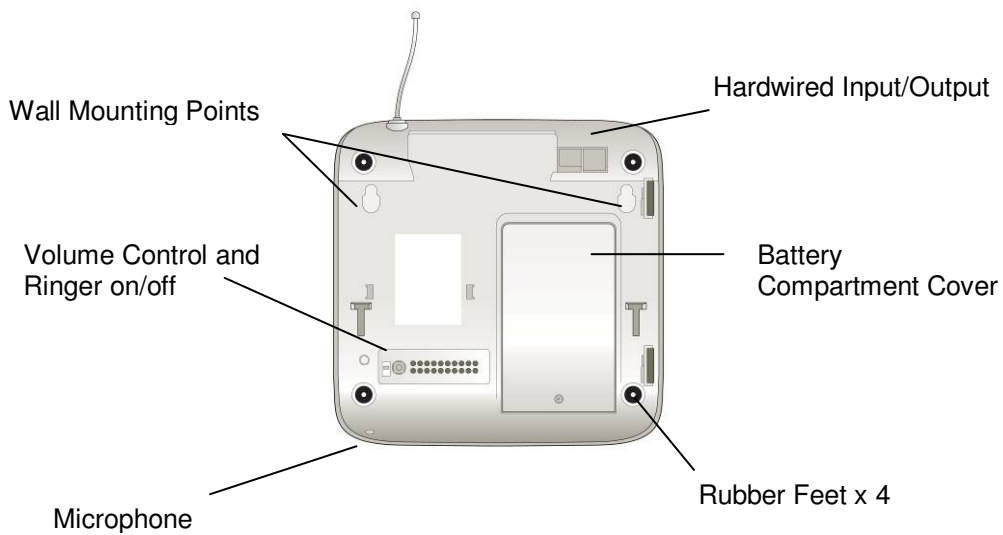

End view

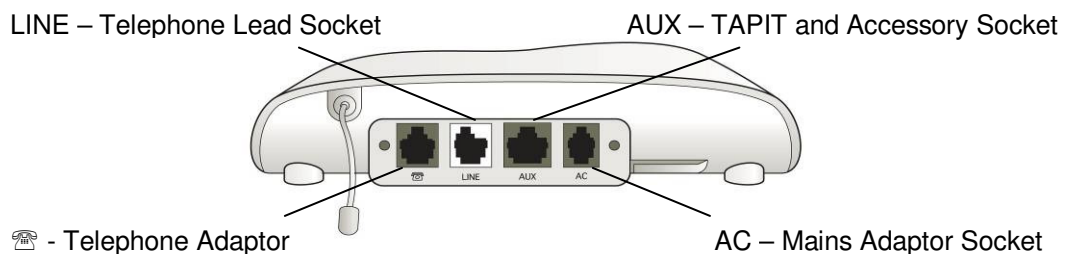

For your safety - Installation advice

IMPORTANT: Connect the home unit to the first telephone point in the house with all other extensions wired into the unit to ensure proper operation even when another telephone is in use or off hook (see below for more detailed instructions).

All equipment requiring a link to the telephone line **MUST** be connected as follows:

Extension phones/smart boxes/modems/TV set top boxes

All telephones in the home **MUST** be plugged directly into the home unit using telephone adaptor **b** and the home unit socket labelled  to enable the home unit to disconnect extension telephones when raising an alarm call. A multiple telephone adaptor may be required to connect more than one telephone (not supplied).

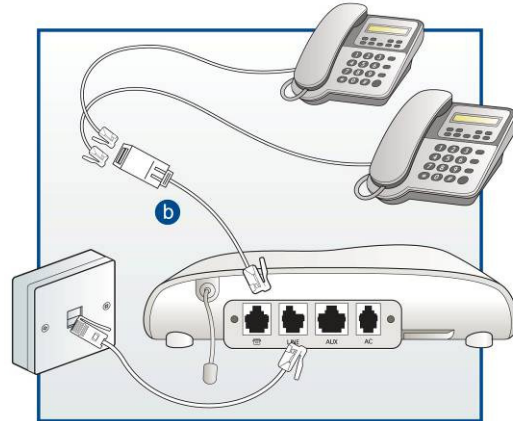

Cordless phones

Ensure that the main base/charger which is registered to all other handsets in use, is connected directly to the home unit as above.

Safe Socket™

Alternatively a Safe Socket (part number 36900/55) can be installed on all extensions used by other equipment, except the Lifeline, to ensure that alarm calls are raised even when the line is being used by another extension. Contact your supplier for more information.

Broadband

Please ensure a high quality ADSL filter is in use and the home unit is connected to the phone (analogue) socket on the filter. Please contact your supplier for further advice if necessary.

Dos

- Keep the home unit connected to the mains power at all times.
- Connect the home unit to the first telephone point in the house with all other extensions wired into the unit to ensure proper operation even when another telephone is in use or off hook.
- Contact your supplier as soon as possible after the LED on the personal radio trigger indicates a low battery.

Don'ts

- Expose the home unit to water or other liquids.
- Connect cables other than those supplied with the home unit.
- Place the home unit next to something that makes lots of noise, such as next to a television, radio or washing machine.
- Place the home unit close to a heat source e.g. cooker or large metal objects e.g. microwave.

Quick start guide

IMPORTANT: In order to function the home unit must be programmed correctly to a monitoring centre or personal recipient (please see programming section).

Step 1 - Connecting the leads and adaptors

Please follow the steps below to plug the leads correctly into the home unit.

Step A – Plug the telephone lead ㉑ into the home unit socket labelled LINE and the first/main telephone wall socket.

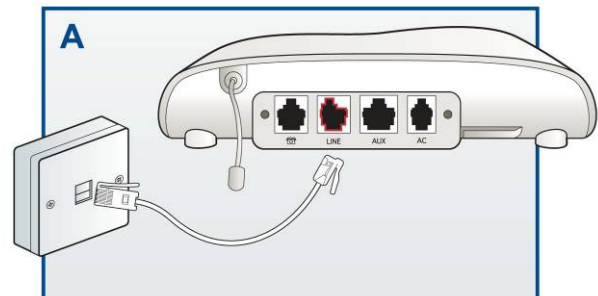

Step B – Plug the telephone adaptor ㉒ into the home unit socket labelled ㉑ and then plug all required telephones / equipment into the telephone adaptor ㉒ using a multi socket extension if required (not supplied). See page 5 for more details.

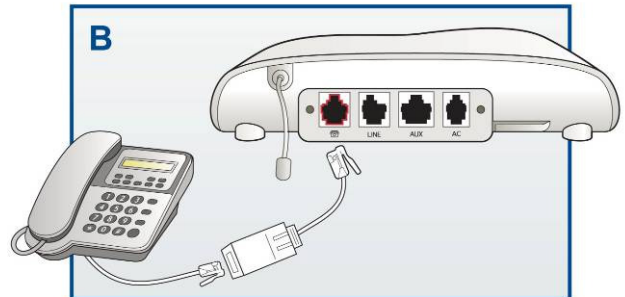

Step C – Plug the mains adaptor ㉓ into the home unit socket labelled AC and then connect to the mains power. Note – ensure the mains power is switched on.

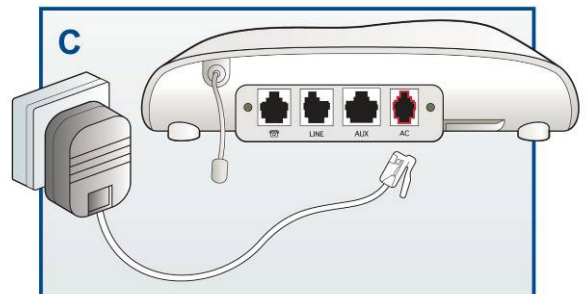

Step D – Adjust speaker volume if required by depressing the volume control button on the underside of the home unit with a pen/pencil. After depressing for a few seconds, the home unit will emit a tone, release the pen/pencil when the tone reaches the required volume.

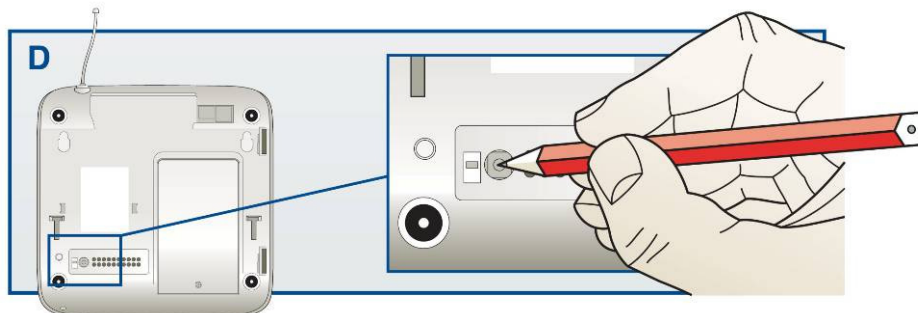

Step 2 - Testing

Ensure the home unit is programmed to the correct telephone numbers (see page 15/16), then press the red alarm button on the home unit and ensure it raises a call through to the monitoring centre/personal recipient. Also remember to test the personal radio trigger by pressing its red button and ensuring a call is raised. The personal radio trigger test should be done at various points around the property to ensure the radio range provides sufficient coverage for the user to raise an alarm call using their personal radio trigger. Remember to also set the time on the home unit if you are using features that rely upon the home unit's realtime clock.

Step 3 – Adding personal triggers/telecare sensors

For more information on adding personal triggers, please see page 11 of this guide. The programming section of this guide also provides further information.

Step 4 – Ready to use

Once successfully tested, the home unit is ready for use.

Wall mounting

Decide where you want to situate the home unit. Remember it should be within 2 metres of a mains power socket and the main telephone line socket. Then drill 2 holes 146mm apart, firmly attach screws (not supplied) leaving the screw heads protruding the surface and then locate the wall mounting points on the home unit with the screws.

A full size template is available to download from the Tunstall website visit www.tunstall.co.uk/downloads, then search for Lifeline Connect/Connect+ wall mounting template.



NOTE: The diagram above is for illustrative purposes only and should not be used as a measuring tool i.e. it is not drawn to scale.

Using the home unit

Making an alarm call

Press the red button on the personal radio trigger or the red alarm button on the home unit.

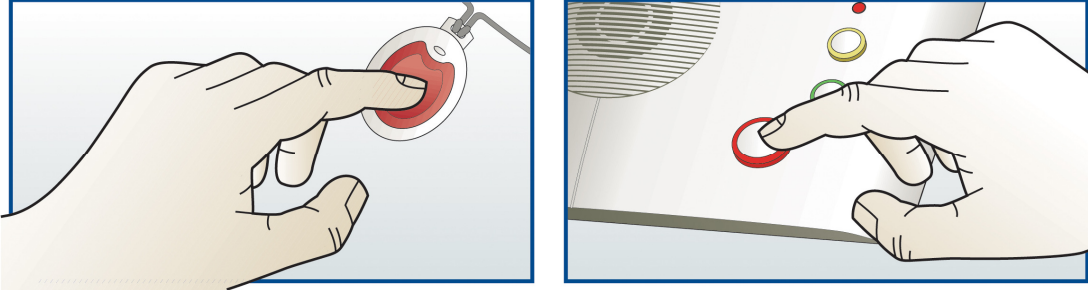

Cancelling an alarm call

Wait 5 seconds (after the alarm button is pressed) and press the green cancel button. This in-built delay prevents false cancellation of an alarm call. Alarm calls made from a personal radio trigger can be cancelled immediately by pressing the green cancel button.

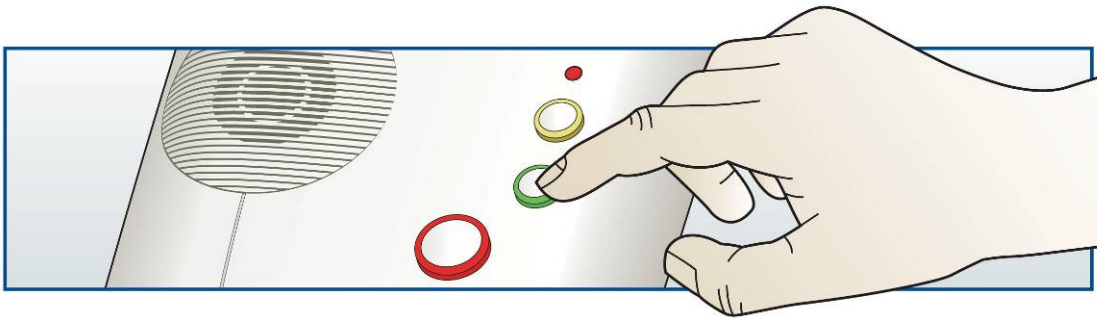

Answering calls remotely via the personal trigger

Personal radio triggers can be used to answer incoming telephone calls remotely by pressing its red button while the home unit or connected telephone is ringing. When pressed, the home unit will answer the call and you can speak to and hear the caller handsfree via the home unit. To revert to handset mode, just pick up the handset of the connected telephone. Replacing the handset will transfer the call back to handsfree mode. To end a handsfree call, press the red button on the personal radio trigger again or press the cancel button. Calls can also be answered in handsfree mode at the home unit by pressing the cancel button.

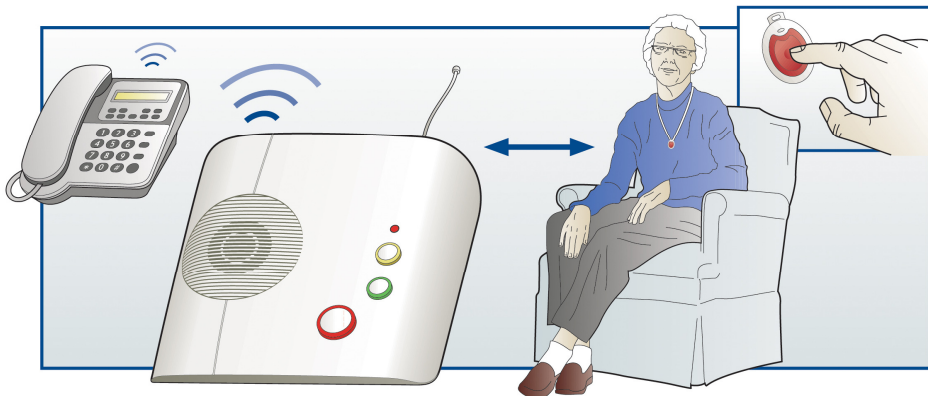

Status warnings

Telephone line monitoring

If the telephone line is faulty or becomes disconnected, the home unit will announce *'WARNING – the telephone line is disconnected'* after 1 minute and the green LED flashes. This warning will be repeated every 30 seconds until the telephone line becomes available again.

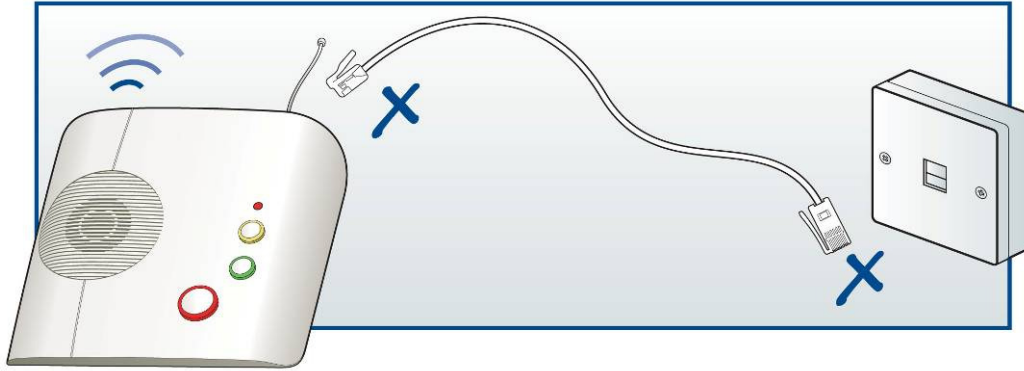

To silence the warning, re-connect the telephone line. If the telephone line is connected and the warning continues, press the green cancel button. If the warning continues you should contact your telephone line supplier (e.g. BT) as the telephone line may be faulty.

Power failure monitoring

If a power failure occurs, the home unit will continue to work using its back-up battery, however, as a warning the red LED will flash once every 4 seconds (see section – what the lights on the unit indicates). The unit will also announce *'WARNING – there is no mains power'*. This warning is repeated every 5 minutes. To silence the warning reconnect the power lead.

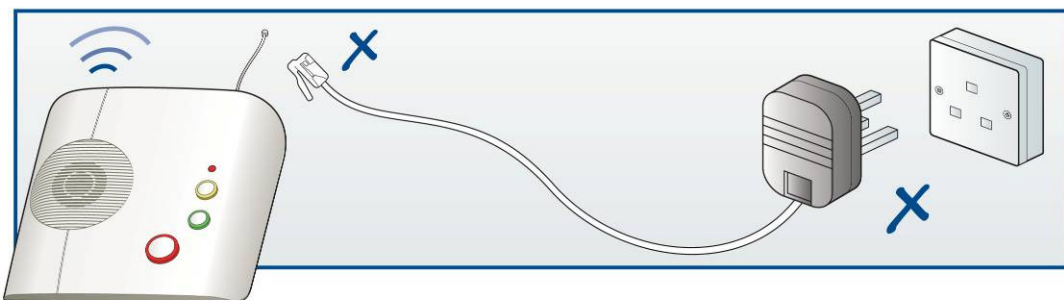

If the power failure lasts for more than 1 hour, during the next hour the unit will automatically call the monitoring centre. A call will be raised every 4 hours to the monitoring centre until the power is restored. The battery provides 30 hours back-up.

The lights on the home unit indicate

The lights on the home unit provide indications of its status based on the below.

Lights	Home unit status
Red alarm button on	Normal mode
Red alarm button flashing (1 every 4 seconds)	Normal mode running on battery (mains power off)
Red alarm button flashing (1 every second)	Alarm mode
Green LED flashing (2 every second)	Telephone line disconnected
Green LED on	Telephone line in use
Green LED flashing (in time with telephone ring)	Incoming call (telephone ringing)
Yellow LED on	Function button in away mode
Yellow LED off	Function button in home mode
Yellow LED flashing (1 every 4 seconds)	Low battery detected
Yellow LED flashing (2 every second)	Intruder entry/exit time period
No lights on	Unit powered down (if power is on and connected then the unit may be faulty)

The LED on the personal radio trigger indicates

When pressed the red LED on the personal radio trigger will light up. This is to indicate that the button has been pressed. If the LED flashes when pressed this indicates that the personal radio trigger battery is low and should be replaced. You should contact your supplier as soon as possible in the event of low battery indication.

Programming a telecare sensor to the home unit

Telecare sensors with plug and play functionality can be programmed to the home unit using the following steps:

Step 1 – Press and hold down the green cancel button until it beeps (approx 5 seconds). The home unit announces ‘Programming mode’ and the red alarm button flashes slowly.

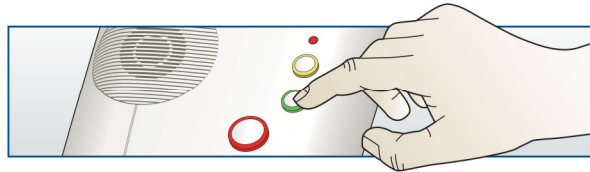

Step 2 – Press and hold down the green cancel button again until it beeps (approx 3 seconds). Release the cancel button, the red alarm button flashes rapidly. The home unit is now in ‘Assign mode’.

Step 3 – Activate the sensor/trigger, the home unit will announce the trigger type to confirm acceptance.

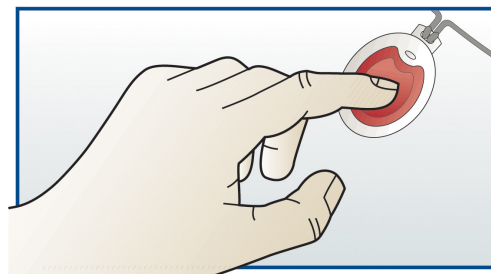

Step 4 – Press and release the green cancel button. The home unit will beep (programming mode exited).

Step 5 – Test the sensor/trigger by activating it and ensuring it raises an alarm call.

If you would like to know which telecare sensors are currently available, please contact your supplier.

NOTE:

Whilst in Step 3 the following quick codes can be entered via the series telephone handset to configure telecare sensors related to the intruder setup.

6003	Set last assigned trigger as a Zone 1 armer
6004	Set last assigned trigger to be a Bogus Caller
6005	Set last assigned trigger to be a Zone 1 and Zone 2 armer
6006	Set last assigned trigger to be Zone 1 and Zone 2 arm/disarmer
6008	Set last assigned trigger to start entry/exit tones on activation
6009	Set last assigned trigger to not start entry/exit tones on activation

Using the below quick code, the last assigned trigger can be given a location.

4zxx	Set the last registered trigger for zone and location	Must be done before exiting program mode where z = 0 for zone 1 and 1 for zone 2, xx = TT21 location code, see table 1
-------------	---	--

Range Test











The home unit has a range test feature that enables you to test the range of personal triggers without raising an alarm call. This is done by putting the home unit into programming mode (press and hold down the green cancel button until it beeps). When in programming mode, press the required personal trigger if it is within range the home unit will beep and announce the trigger or telecare sensor type.

Programming guide

Programming of the home unit and its functions can be achieved using three different methods:

- **PC Connect programming tool** – full programming can be achieved using a TAPIT programming tool linked to the home unit and a laptop running PC Connect software. Full help files are provided within the software.
- **PNC software** – this method allows more in depth remote programming at the monitoring centre using custom designed screens within the PNC software (depending upon the software version) or via manual entry of parameters.
- **Series telephone** – basic user programming can be achieved by using the keypad of a phone connected to the serial telephone socket of the home unit. This includes quick codes and manual entry of parameters. Instructions are included within this programming guide.

The following table provides an overview of which features can be configured using the above programming tools. For a full list of which features each Lifeline home unit can support, please see the 'Features at a glance' section.

Icon	Feature	PC Connect	PNC4 V2.5.1	PNC5/6	Series Telephone
	Telephone Numbers & IDs	Full	Full	Full	Basic keypad codes
	Inactivity Monitoring	Full	Basic keypad/user option codes or Manual Entry	Basic keypad/user option codes or Manual Entry	Basic keypad/user option codes
	Call Sequences	Full	Full	Full	None
	Intruder & Away Options	Full	Basic quick codes or Manual Entry	Basic quick codes or Manual Entry	Basic quick codes
	Radio Triggers & Events	Full	Basic add/delete	Basic add/delete	Basic keypad codes
	Periodic Calls & AP (Auto Presence)*	Full	Full	Full	None
	Hardwired Input	Full	Full	Full	Basic quick codes
	Event Configuration	Full event based configuration	Non telecare sensor alarms/events only	Non telecare sensor alarms/events only	None
	Manual Entry** & Quick Code	Yes	Yes	Yes	Yes
	Fault Monitoring	Full	Mains and telephone line failure only	Mains and telephone line failure only	Basic keypad codes

	Reminders***	Fully configure (excluding recording)	None (done via IVR)	None (done via IVR)	Quick codes (just recording)
	Critical Visits***	Full	Manual Entry	Manual Entry	None
	Keyless Entry***	Full	Manual Entry	Manual Entry	None
	Auto Answer***	Full	Manual Entry	Manual Entry	None
	Time & Date	Full	Full	Full	Keypad code
	Speech Configuration	Full	Manual Entry	Manual Entry	None
	Output Configuration***	Full	Full	Full	None
	Remote Output Control	None	Full	Full	None
	Virtual Sensor Setup***	Full	Settings adjustable, initial setup via PC Connect	Settings adjustable, initial setup via PC Connect	None
	ADLife Configuration***	Full	None	None	Quick Codes
	Line Ringing Configuration	Full	None	None	None

* Auto Presence is not supported in the UK

** Programming home units using manual entry should only be done when advised by Tunstall.

***Lifeline Connect+ features only

How to program via PC Connect programming software

Home units can be connected to a laptop/PC using a TAPIT interface. The computer requires PC Connect software loading onto it (this can be downloaded from www.tunstall.co.uk/downloadcentre). The software provides the ability to access enhanced programming features that series telephone/remote PNC programming does not provide access to.

The software includes detailed help files that explain all the features and how they can be tailored to meet the needs of individual people.

Existing TAPIT programming interfaces can be used as the interface between the home unit and the laptop/PC. Additional TAPITs can be purchased using part number 36900/01.

How to program via PNC software

PNC5 or 6

Using PNC5 or 6 monitoring software the operator can use custom designed screens to program the features of the home unit remotely.

PNC4

In order to program the home unit from PNC4, version 2.5.1 is required, please contact Tunstall's customer satisfaction centre on 0844 415 2414 if your system requires updating. Older PNC4 software (version 2.5.0 and below) will recognise the home unit as a Lifeline 4000+ home unit however remote programming of the unit should not be done.

How to program using a series telephone

Step 1 – Connect a telephone directly to the socket on the home unit labelled .

Step 2 – Place the home unit in to programming mode by pressing and holding down the green cancel button until it beeps (approx 5 seconds). The home unit announces 'Programming mode' and the red alarm button flashes slowly.

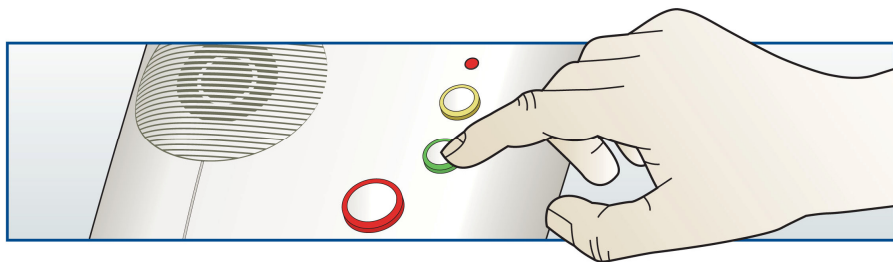

Step 3 – Lift the handset of the telephone and enter the quick codes listed on the following pages. Manual entry of parameters can also be completed via this method, however this should only be used when advised by Tunstall.

NOTE: All programming not listed in this guide must be completed using the PC Connect programming tool or via the monitoring centre.

Frequently used series telephone codes

Enter programming mode as described on the previous page, lift the telephone handset and then enter the following codes:

Resetting the home unit but retaining radio triggers

To reset all previous programmed information except the radio triggers, press:



This code means all functions are reset to default settings. The date and time remain unchanged.

Resetting the home unit

To reset all previous programmed information press:



Resetting erases all programmed telecare sensors and triggers and all functions are reset to default settings. The date and time remain unchanged.

Setting the time and date

There is a real time 24 hour clock in the home unit which automatically adjusts to BST. During power cuts the clock is backed up by the home unit's battery for up to 30 hours. However if the unit is powered down for transit then the clock must be reset again when the home unit is installed in the user's home. To set the clock press:



DD represents the day of the month (01-31)

MM represents the months (01-12)

YY represents the two digit year (00-99)

HH represents hours 00-23; 24 cannot be programmed

MM represents minutes 00-59; 60 cannot be programmed

X represents the daylight saving time zone (0 = disabled, 1 = Europe, 2 = US)

Y represents enable/disable auto CLI time update feature (0 = disable, 1 = enable)

Telephone numbers

The series telephone keypad supports the programming of 10 alarm numbers. By default, telephone numbers 1-4 are set to call control centres (CC) and telephone numbers 5-10 are set to a Personal Recipient (PR) destination. To change the destination from CC to PR or normal telephone (POTS) see the next section.

Control centre numbers

Control centre numbers are programmed by pressing:



Sets telephone number 1

To set tel. number 2 replace 00 with 01
 To set tel. number 3 replace 00 with 07
 To set tel. number 4 replace 00 with 08
 To set tel. number 5 replace 00 with 09
 To set tel. number 6 replace 00 with 10

To set tel. number 7 replace 00 with 39
 To set tel. number 8 replace 00 with 40
 To set tel. number 9 replace 00 with 41
 To set tel. number 10 replace 00 with 42

NOTE: A pause can be entered when programming alarm numbers by pressing #2 as part of the telephone number.

Changing telephone number destination to PR or POTS

To program an existing telephone number to a PR or POTS destination, press:

XY

Where X represents the telephone number position (1-9 with 0 = 10)
 Where Y represents the destination type CC (0), PR (1) and POTS (2)

NOTE: It is important to set the correct destination type otherwise the recipient of the alarm call will not be able to deal with it correctly. A CC call expects a particular handshake from the control centre, a PR call requires a recipient with a touch tone telephone and a POTS call is a normal telephone call (i.e. fast dial button).

Unit ID numbers

The home unit sends a unit ID number to the monitoring centre when an alarm is sent. The number identifies which home unit is sending the alarm. Unit ID number 1 must be programmed into the home unit (default 995) in order for an alarm to be sent. The unit ID number may be the same for all monitoring centres and personal recipients. If required the home unit can be configured to send a different unit ID to each telephone number it is programmed to call.

Adding/Changing a unit ID

Unit IDs can be programmed into the home unit by pressing:

Unit ID (max 12 digits)

Sets Unit ID 1

To set Unit ID 2 replace 02 with 12
 To set Unit ID 3 replace 02 with 13
 To set Unit ID 4 replace 02 with 14
 To set Unit ID 5 replace 02 with 15
 To set Unit ID 6 replace 02 with 16

To set Unit ID 7 replace 02 with 17
 To set Unit ID 8 replace 02 with 18
 To set Unit ID 9 replace 02 with 19
 To set Unit ID 10 replace 02 with 20

Deleting a unit ID

To delete a unit ID press:

Deletes Unit ID 1. Replace 02 with the numbers identified above to delete the appropriate Unit ID number.

NOTE: If no unit ID is linked to a telephone number, the first valid code will be used. The actual number of digits sent to the alarm receiver depends upon the type of monitoring centre being used. Please contact your monitoring centre for more information.

Selecting DTMF or STMF

Traditionally all home units have used Dual Tone Multi Frequency tones to communicate with monitoring centres. As a result of network changes, these can on occasion be corrupted therefore a new signalling method Sequential Tone Multi Frequency (STMF) has been designed. All Lifeline Connect+ home units manufactured since week/year 0710 (Lifeline Connect week/year 11 11) have already been configured to allow the STMF method to be utilised. In these units, if a DTMF failure does occur then the home units will automatically switch to STMF for subsequent alarm dial attempts and will then continue to use STMF in preference to DTMF for all future alarm calls.

Using the following quick codes, Lifeline Connect+ home units (manufactured since week/year 07 10) and Lifeline Connect home units (manufactured since week/year 11 11) can easily be set to use DTMF or STMF.



Unit chooses DTMF or STMF (default status).



Unit always uses DTMF (should be used when communicating to a monitoring centre that cannot support STMF).



Unit always uses STMF (for use when operating on GSM and/or NGN networks).

NOTE: Before using STMF, the PNC monitoring centre and back up centre must be configured to receive STMF protocol. Lifeline Connect and Connect+ home units manufactured since week/year 14 09 can be configured to use STMF protocol using PC Connect or remotely from PNC.

Prefix numbers

A function can be enabled/disabled to ensure a prefix number is inserted before all dialled numbers from the home unit e.g. dialling 9 when using a PBX. This can be achieved by pressing:



Suffix numbers

To program a suffix please use PC Connect software.

User Options Codes

The following table provides a two digit code that enables you to set parameter 11 very simply. For example, to set a home unit to have;

No inactivity monitoring, no line fail warnings (audio or visual) but with mains audio fail warning on, press;

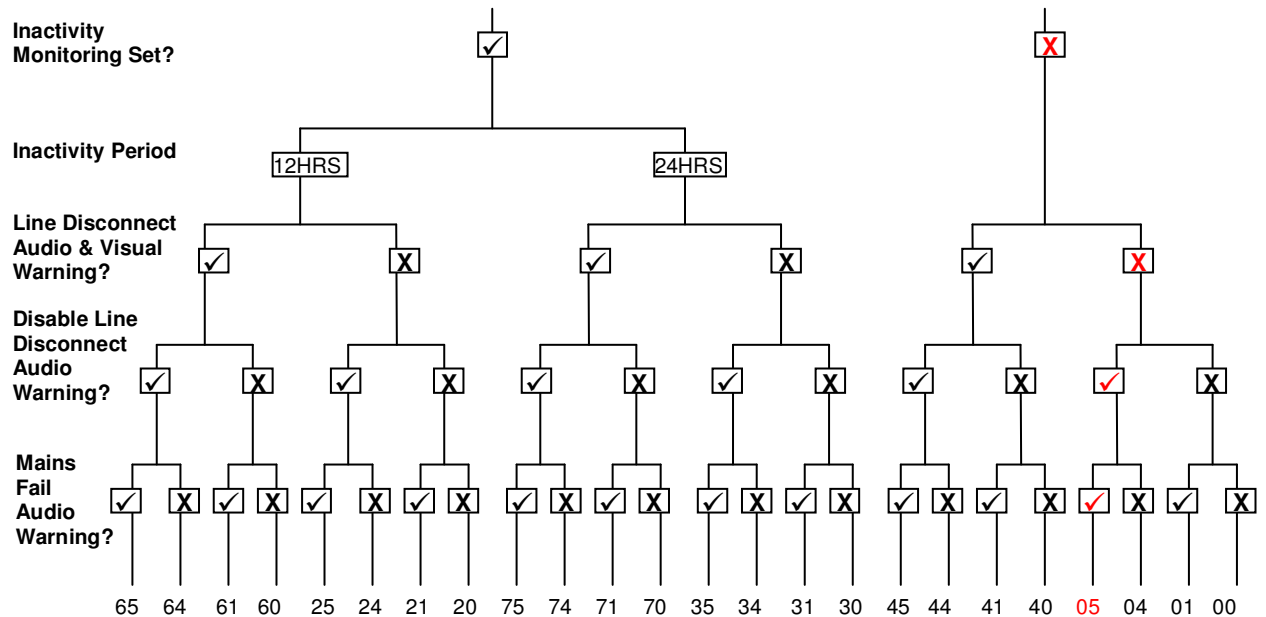

Quick Codes

Both the Lifeline Connect and Connect+ home units have a number of quick codes that can be entered into the series telephone when the home unit is in programming mode or remotely via PNC4 (v2.5.1) and PNC5/6.

Quick Code	Purpose	Comments
2040	Reset to default but retain radio triggers	Time and date remain unchanged
2050	Reset to factory defaults	Time and date remain unchanged
2060	Delete ALL radio triggers	Restores to default
3000	Delete the next radio trigger transmitted	Must activate trigger
4zxx	Set the last registered trigger for zone and location	Must be done before exiting program mode where z = 0 for zone 1 and 1 for zone 2, xx = TT21 location code, see table 1
45xx	Set hardwire input to trigger type number	Where xx trigger type code, see table 2
46xy	Set hardwired input sensor	x = 0 for disable, 1 = n/o, 2 = n/c y = 1 for zone 1 and 2 = zone 2
47xx	Set hardwired input location	Where xx is TT21 location code, see table 1
48xy	Set destination	Where x is telephone number 1 to 10 (0 = 10) y = 0 for CC, 1 for PR and 2 for POTS
51xx	Enable inactivity monitoring for a period of 12 or 24 hrs	Where xx is 12 or 24

Installation and Programming Guide

6001	Enable intruder	Default entry/exit time 30 secs
6002	Disable intruder	
6003	Set last assigned trigger as a Zone 1 armer	Home unit must be in assign mode
6004	Set last assigned trigger to be a Bogus Caller	Home unit must be in assign mode
6005	Set last assigned trigger to be a Zone 1 and Zone 2 armer	Home unit must be in assign mode
6006	Set last assigned trigger to be Zone 1 and Zone 2 arm/disarmer	Home unit must be in assign mode
6008	Set last assigned trigger to start entry/exit tones on activation	Home unit must be in assign mode
6009	Set last assigned trigger to not start entry/exit tones on activation	Home unit must be in assign mode
61xx	Enable intruder and set entry/exit tones	Where xx is in seconds
6413	Enable intruder disarm method of AWAY and personal trigger	
6403	Disable intruder disarm method of AWAY and personal trigger	
6414	Enable intruder disarm method by PIN	
6404	Disable intruder disarm method by PIN	
6415	Enable intruder disarm method by arm/disarm trigger	
6405	Disable intruder disarm method by arm/disarm trigger	
9000	Home unit automatically switches between DTMF and STMF (default status)	
9001	Home unit always uses DTMF	
9002	Home unit always uses STMF	This should be used for GSM and Next Generation Networks.
9101	Make all event calls silent and visual	Alarm button will flash
9108	Make all event calls silent and non visual	Alarm button does not flash
9103	Restore all event calls to default states	

The following quick codes are only supported on the Lifeline Connect+

Quick Code	Purpose	Remarks
3011	Activate external relay for 2 seconds	All alarms (Call Raised)
3012	Activate external relay for all alarms when call selected and de-activate when calls cleared	Call Selected Call Cleared
3013	Activate external relay on radio smoke alarm and de-activate when cleared	Smoke Alarm Call Cleared
3014	Disable external relay for all events	
650x	Disable Virtual PES for x minutes	
6550	Purge ADLife data	
6551	Test call for ADLife	
7000	Record PR message	
7010	Delete PR message	
7001	Record reminder message #1	
7002	Record reminder message #2	
7003	Record reminder message #3	
7004	Record reminder message #4	
7005	Record reminder message #5	
7006	Record reminder message #6	
7011	Delete reminder message #1	
7012	Delete reminder message #2	
7013	Delete reminder message #3	
7014	Delete reminder message #4	
7015	Delete reminder message #5	
7016	Delete reminder message #6	

Features at a glance

The table below provides a full list of the features available in the Lifeline Connect and Lifeline Connect+.

Safety features	Lifeline Connect	Lifeline Connect+
869 MHz European Social Alarm frequency - compatible with Tunstall's full range of telecare sensors.	✓	✓
Radio reliability - the EN300 220-2 (2007) Class 1 radio receiver ensures that signals from sensors are reliably received.	✓	✓
Periodic calls - an automatic test call can be set up to ensure the unit is working properly.	✓	✓
Backup battery monitoring - unit reports the status of its backup battery to the monitoring centre.	✓*	✓*
Programming & Installation features		
10 telephone numbers (Monitoring Centre, Personal Recipient, POTS) - allows a different number to be dialled depending on what generates the alarm by routing calls to the most appropriate recipient.	✓	✓
Plug & Play registration - telecare sensors can be assigned quickly and easily, together with their location within a dwelling, reducing installation times.	✓	✓
Local programming - basic parameters and quick codes can be carried out using a normal telephone handset.	✓	✓
Range test and walk test features - allow the radio range of the pendant and telecare sensors to be easily tested.	✓	✓
Advanced local programming - downloadable PC Connect software application for programming of home unit via a connected PC or laptop (requires TAPIT programming interface).	✓	✓
Telecare sensor inputs - the number of sensors that can be linked to the home unit.	12	35
TT92 protocol support – provides the monitoring centre with additional telecare information such as the type of telecare sensor that generated the alarm call.	✓	✓
STMF protocol – an alternative protocol that is specifically designed for use on digital telephone networks including GSM networks.	✓**	✓**
TT21 protocol support – provides enhanced and more detailed information to the monitoring centre and offers flexibility for future use.		✓
Service Support features		
Intelligent Speech Switching - ensures the best quality of speech depending on how the alarm was generated (requires PNC4 or later monitoring centre).	✓	✓
Automatic British Summer Time update - removes the need to manually adjust the clock on the unit.	✓	✓
User features		
Telephone answering with personal trigger - users can answer incoming telephone calls hands-free by simply pressing their personal trigger.	✓	✓
Configurable audible ringing - can be set up to get progressively louder the longer the call goes unanswered.	✓	✓
Automatic audible warning alerts - the unit alerts the user to mains and telephone line failure/resumption with a visual or audible and visual signal.	✓	✓
New ergonomic design - a contemporary design to fit into the modern home environment.	✓	✓
Easy switching between hands-free and handset mode - hands-free calls can easily be made private by picking up the handset of an attached telephone.	✓	✓
Optional local audible warnings - non-critical warnings such as mains failure can be turned off at night to avoid disturbing the user.	✓	✓
Technical call queuing - if the telephone is in use, non-critical calls (e.g. low battery warning) will be queued until after the call has ended, thereby not interrupting your call.	✓	✓
Ability to signal a 'beep' - if the user is unable to speak in the event of an alarm, they can press their personal trigger during an alarm call to signal to the monitoring centre.	✓***	✓***

*Feature included in Lifeline Connect and Connect+ home units manufactured after week 05 year 11.

**Feature included in Lifeline Connect and Connect+ home units manufactured since week 14 year 09. However some home units need configuring to utilize the feature. For more information please refer to www.tunstall.co.uk/productsupport

***Feature disabled by default.

Key features	Lifeline Connect	Lifeline Connect+
Away mode button - suspends inactivity monitoring and switches to intruder monitoring mode.	✓	✓
Intruder alarm functionality - a simple to use zoned intruder system that can be armed by a press of a personal radio trigger to give additional user protection and reassurance against the fear of crime.	✓	✓
Basic inactivity monitoring - checks for inactivity over a 12 or 24 hour period.	✓	✓
Basic fixed-phrase personal recipient speech - personal call recipients will hear 'This is an alarm call from unit 1234' only.	✓	✓
Event Based Configuration - all events are configurable to select the required behaviour and response to events.	✓	✓
Virtual Sensors - intelligently process a series of events to determine an alarm condition and ensure the most appropriate action is taken. Three virtual sensors are available - inactive client in room; bed/chair absence and property exit.		✓
Integrated ADLife - Activities of Daily Living monitoring capability (requires a data capture facility). For further information please refer to the ADLife solutions sheet.		✓
Critical visits management facility - enables an alert to be raised if a carer has not made and confirmed a scheduled visit to the user's home.		✓
Auto Answer - allows the home unit to answer calls from known telephone numbers, e.g. monitoring centre, enabling remote programming to be carried out without disturbing the user (requires Caller Line Identification on the telephone line).		✓
Keyless door entry - allows authorised entry into a user's dwelling on activation of an alarm call without the need for an external key safe or a key holder to respond. Requires power supply and electric lock release.		✓
Reminder facility - reminds the user about key information e.g. medication times through the use of automatic reminder messages that require user confirmation for added peace of mind.		✓
User recordable messages - allows messages to be recorded and used for personal recipient calls (e.g. This is an alarm call from Mrs Smith) and reminder purposes.		✓
Advanced personal recipient speech - enhances the information provided to personal call recipients by adding the type of telecare sensor that generated the call along with its location and battery state.		✓
Advanced inactivity monitoring - increases the flexibility of inactivity monitoring by allowing for inactivity to be checked over two separate time windows.		✓
Alarm control by time – this feature stops the alarm unit from generating an alarm for specific events that occur during a specified time period e.g. low temperature call during the night.		✓
Connectivity features		
Hardwired input - for connection from other devices.	✓	✓
Hardwired output - for connection to other devices.		✓
MyLife compatible - enables home unit to turn on/off electrical appliances using X10 and also communicate with the DDA pager solution.		✓
GSM compatible - enables the home unit to send alarm calls via mobile telephone networks where a normal telephone connection is not available. Part number: 53000/640 only	✓ Requires STMF protocol**	✓ Requires STMF protocol**
Inductive Loop compatible – allows television and alarm call sounds to be replayed to the user's hearing aid to improve the quality of television watching and help them to hear the monitoring centre		✓

**Feature included in Lifeline Connect and Connect+ home units manufactured since week 14 year 09. However some home units need configuring to utilize the feature. For more information please refer to www.tunstall.co.uk/productsupport

Features explained

Telephone numbers & IDs

Up to 10 telephone numbers can be entered in the boxes. The destination type has to be changed to the correct type for each telephone number. There are three different destination types:

- Control centre - this should be used for all telephone numbers used for control centre call handling
- Personal recipient - this should be used for sending an alarm call to a normal house phone or mobile phone
- POTS - this is used when setting up a fast dial button on the home unit e.g. the away button used a fast dial button

The home unit sends a unit ID number to the control centre when an alarm is sent. The number identifies which home unit is sending the alarm. The specific unit ID field enables you to enter a different unit ID for each telephone number

Call sequences

The call sequence consists of up to 10 telephone numbers that the home unit can be set to dial in any order with multiple attempts to each alarm number. The home unit will ring each number in the order set up via PC Connect or PNC. If the home unit reaches the end of a call sequence without the alarm being answered it will start again at the beginning of the sequence. There are a total of 10 call sequences.

Away button options

The away button can be set to provide different actions when pressed, these include:

- Standard Home/Away - the Away button will suspend inactivity monitoring and arm the intruder alarm if it is enabled.
- Service Key - the Away button act as a fast dial button and call a designated telephone number when pressed.
- Check in/Out Button - Setting the Away button to a Check in/Check Out Button will raise a carer arrived event on the initial press and a carer departed event on the subsequent press.

Radio triggers

The Lifeline Connect supports up to 12 (Lifeline Connect+ = 35) telecare sensors/radio triggers. Using PC Connect the radio triggers can be set up with the correct trigger type, location code and the usage of the trigger e.g. whether it is used as part of a virtual sensor.

Periodic calls

The home unit allows a periodic call event to be generated either at a configurable period or at a fixed time. In the configurable period case, the period between events can range from seconds through to days. In the fixed time case, the period between events is a configurable number of days. When the unit is configured to generate periodic call events at a configurable period, an initial offset time can be specified which must elapse before the first periodic call event is generated. This feature allows a unit that is configured during the day to generate periodic call events at a more appropriate time i.e. during the night.

Backup battery monitoring

The unit battery low feature is operated using parameter 174 and if enabled provides the following alerts:

1. **Under mains failure condition** – home unit alerts monitoring centre when the home unit battery reaches 1/3 of its capacity and therefore has approximately 8 hours remaining back up time. This alert is in addition to the existing alerts provided during a mains failure situation.
2. **Battery terminal voltage too high or too low** – this alert is provided at any time when the battery voltage goes above or below set limits indicating a unit battery fault or failure.

If mains failure alerts are received close to the 'System Battery Low' and 'Battery or Unit Failure' messages then it can be assumed that the message relates to the battery backup time remaining during a power failure. Therefore this alerts the monitoring centre that there is only 8 hours battery time remaining until the unit will shut down unless the mains power is restored.

Alerts received when no mains failure alerts have been received relate to a battery fault or failure. Such alerts should be dealt with promptly by replacing the unit's back up battery. These can be ordered from Tunstall using part number D3706005A.

All home units manufactured from 31st Jan 2011 (week 05 year 11) now include the feature. This supports battery management procedures and in particular avoids the need to carry out the 6 monthly unit battery tests as previously recommended and will also raise alerts to any battery failures at the earliest opportunity.

All Lifeline Connect and Connect+ (manufactured prior to week 05 year 11) can also support the feature and the feature can be turned on using either PC Connect (Fault monitoring section) or remotely using PNC (parameter 174).

Intruder monitoring

The home unit has the ability to provide a simple to use intruder alarm facility, which will alert the monitoring centre or personal recipient on detection of an intruder.

When configured using the series telephone keypad, the intruder monitoring function is simplified and uses a number of default settings. These settings other than the entry/exit times period, can only be configured using the PC Connect programming tool or via the monitoring centre.

By turning the function ON using the keypad, Intruder monitoring will use the following settings.

- Arm method – press function button, unit announces ‘Away’ and entry/exit tones will be heard for 30 seconds.
- Disarm method – press away button followed by the personal radio trigger, the unit will announce ‘Home’ and the entry/exit tones will stop.

To configure the intruder settings use the following quick codes:

61xx	Enable intruder and set entry/exit tones	Where xx is in seconds
6413	Enable intruder disarm method of AWAY and personal trigger	
6403	Disable intruder disarm method of AWAY and personal trigger	
6414	Enable intruder disarm method by PIN	
6404	Disable intruder disarm method by PIN	
6415	Enable intruder disarm method by arm/disarm trigger	
6405	Disable intruder disarm method by arm/disarm trigger	

If an intruder detection event is detected that is within the armed zone(s) and is from an entry/exit sensor then the entry period will commence and entry tones will sound. The user has until the entry period expires to disarm the intruder system otherwise an intruder alarm will be generated.

NOTE: The intruder function can be configured to meet the individual user’s need using either the PC Connect programming tool or via the monitoring centre. This enables more complex settings to be configured including: different arming methods, optional entry/exit tones, how the unit reacts to intruder detection events (event-based configuration), zoning etc.

Event configuration

This feature enables the home unit to react to each event in a different way and allows these events to be configured via PC Connect and PNC (non telecare sensor events only) based on whether they should; raise an alarm call, act as an intruder/inactivity system input, provide visual/audible reassurance, enable the microphone/speaker, operate the relay output plus much more. The events are split into the following categories:

- Buttons
- Virtual sensors (Lifeline Connect+ only)
- Faults
- Telephony
- Misc

Hardwired input

The hardwired input is located on the underside of the unit with a green 2 wire sprung terminal block. Inputs can be normally open or normally closed volts free contacts.

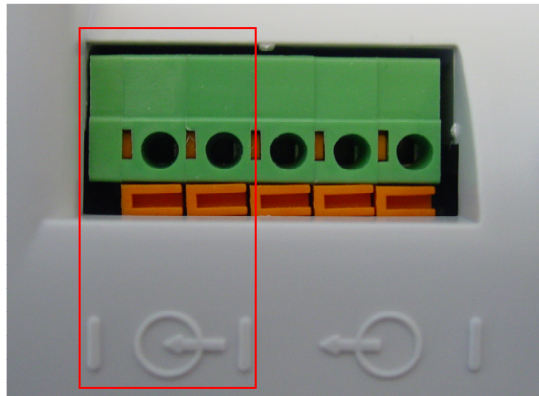

To set an input you will need to configure the unit accordingly either with the serial telephone Quick Codes below, a PNC5/6 monitoring centre or via PC Connect.

45xx	Set hardwire input to trigger type number	Where xx trigger type code, see table 3
46xy	Set hardwired input sensor	x = 0 for disable, 1 = n/o, 2 = n/c y = 1 for zone 1 and 2 = zone 2
47xx	Set hardwired input location	Where xx is TT21 location code, see table 2

Fault monitoring

Fault monitoring enables the settings to be changed to ensure the home unit reacts in the required way when it senses a fault such as power, telephony and battery failures.

Speech configuration

This feature configures how the speech prompts programmed into the home unit are used during alarms, local warnings and programming. Please see the help files within PC Connect for more details. Lifeline Connect only supports basic reassurance speech configuration whereas Lifeline Connect+ offers complete speech configuration.

Inactivity monitoring

The home unit can monitor movement around the home and send an alarm call to the monitoring centre if no movement is detected within a specific time period.

Inactivity monitoring has three different modes, Lifeline Connect supports only simple inactivity monitoring (mode 1) whilst Lifeline Connect+ supports all three modes.

Mode 1 - Simple – generates an alarm if the user is inactive for a configurable 12 or 24 hour period (continuous period). (Lifeline Connect and Connect+)

Mode 2 - Real Time – generates an alarm if the user is inactive between a configurable start and end time (time window). Two time windows are supported e.g. 7am – 10am and 4pm – 7pm (Lifeline Connect+ only).

Mode 3 - Elapsed – generates an alarm if the user is inactive for a period of time within a time window or continuous period. Two monitoring windows are supported e.g. raise an alarm call if the user is inactive for any 1 hour period between 7am-10am and any 40 minute period between 4pm – 7pm (Lifeline Connect+ only).

In all modes, before an inactivity alarm is raised an inactivity warning period will occur. This is fixed at 10 minutes for Mode 1 and is configurable between 0 and 9 minutes for Modes 2 and 3. This warning period is intended to inform the user that an inactivity alarm is about to be raised therefore giving them the opportunity to cancel the alarm.

After an alarm has been raised, inactivity monitoring can either be suspended until further activity is detected (all Modes) or can optionally restart immediately (Modes 2 and 3 only).

When configured using the quick code, inactivity monitoring is simplified using default settings. The following quick code can be used to enable simple (mode 1) inactivity monitoring.

51xx	Enable inactivity monitoring for a period of 12 or 24 hrs	Where xx is 12 or 24
-------------	---	----------------------

Configuration of advanced inactivity monitoring must be done via the PC Connect programming tool or monitoring centre.

NOTE: To avoid false calls to the monitoring centre, inactivity monitoring should be de-activated when the user leaves their home.

- **Activate (home mode)** - press the yellow away button (unit announces 'Home' and the yellow LED will turn off)
- **De-activate (away mode)** - press the yellow away button (unit announces 'Away' and the yellow LED will turn on)

The home unit's clock must be set to operate Inactivity monitoring.

Personal recipient messages

Dealing with personal recipient calls from a touch-tone telephone

Alarm calls can be sent to personal recipients, when a personal recipient receives an alarm call they will hear a spoken message 'This is an alarm call from' followed by either the Unit ID or a recorded message e.g. Mrs Smith (Lifeline Connect+ only – see next section). The recipient can then handle the call using their keypad as follows:

Function	Button	Notes
Accept Call	5	
Clear Call	* then #	Call must be accepted first
Volume up	1	Alters home unit volume
Volume down	2	
Talk	7	Only required if mode is changed from Hands-free Voice Switched (HVS) to tone switched by pressing 7 followed by *.
Listen	*	

Recordable personal recipient messages (Lifeline Connect+ only)

A personal recipient message can be recorded on the Lifeline Connect+ home unit to replace the ID message that a personal recipient would normally hear when they receive an alarm call.

To record the message, press:

Then record the message

Note: if a message is already recorded, this key sequence will replay the message. If this is the case the message must be deleted before a new message can be recorded.

To delete the message, press:

Hardwired output (Lifeline Connect+ only)

The hardwired output in the Lifeline Connect+ home unit provides common (COM), normally closed (NC) and normally open (NO) contacts.

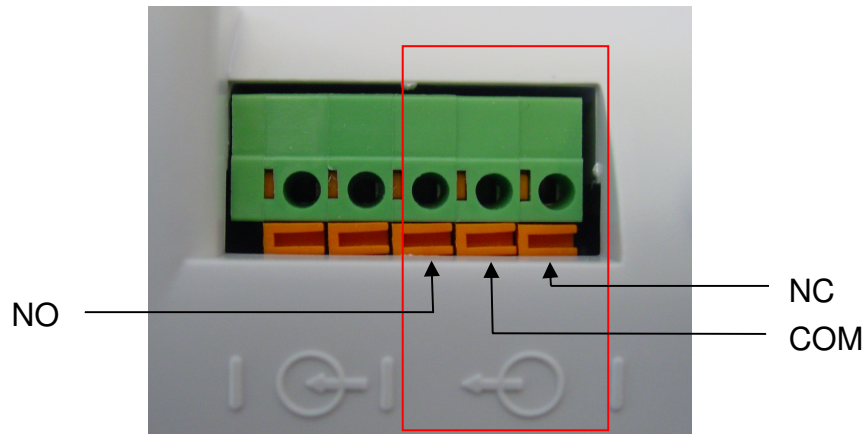

Its operation can be controlled via a series telephone using the quick codes below, or by setting the correct boxes in the Remote Output Control of PC Connect or remotely by a PNC5/6 monitoring centre.

3011	Activate external relay for 2 seconds	All alarms (Call Raised)
3012	Activate external relay for all alarms when call selected and de-activate when calls cleared	Call Selected Call Cleared
3013	Activate external relay on radio smoke alarm and de-activate when cleared	Smoke Alarm Call Cleared
3014	Disable external relay for all events	

Reminder functionality (Lifeline Connect+ only)

The Lifeline Connect+ home unit allows up to 6 voice reminder messages to be recorded onto the unit and then played back at a given time on a one-off or daily basis. Messages can be recorded locally using a series telephone keypad or remotely using an interactive voice response (IVR) system. PC Connect software is required to program reminder messages recorded locally using a telephone keypad.

Listening to a reminder message

When a message is due to be played, the home unit will announce 'Reminder' every 30 seconds and the user must press the cancel button to hear the message. If the user does not acknowledge the message then a 'reminder-no acknowledge' alarm will be raised.

Setting up via IVR

In order to use the IVR method, the home unit must be called from another telephone and the incoming call answered by pressing the cancel button or personal radio trigger. The caller will be able to set reminder times and record messages using a system of IVR prompts and menus (see below). Alternatively, the home unit can be programmed via PC Connect to auto answer incoming calls using Caller Line Identification (CLI) and automatically divert the caller to the IVR reminder menu.

NOTE: The home unit's clock must be set to operate reminder functionality.

IVR reminder menu

Step 1 – Use a normal telephone (or mobile phone) to call the home unit.

Step 2 – Answer the call using the personal trigger or cancel key. If the call is answered by the user on their normal telephone, you must ask them replace the handset and answer the next call using their personal trigger or cancel key. Then call the home unit again.

Step 3 - When answered correctly, press on the telephone keypad

Step 4 - You will then be prompted to key in the PIN (default 1234)

Step 5 - The time currently held on the home unit’s internal clock will then be confirmed.

Step 6 - You will then be given the below menu options. Firstly alter the time* if incorrect (menu option 3) and then follow the menu to configure and record each message.

MENU	INSTRUCTIONS
To add a reminder, press 1	Please type in the hour and then press *. Please type in the minute and then press * To repeat this reminder once only, press 1, to repeat this reminder daily press 2. Please record the reminder message now. Then return to main menu.
To listen to or remove a reminder, press 2	Each reminder will be replayed followed by: To save this reminder, press 1. To remove this reminder, press 2. Then return to main menu.
To set the time, press 3	Please type in the hour and then press *. Please type in the minute and then press *. The time will then be confirmed.
To hang up, press 4.	
NOTE: Times must be entered in 24 hour format e.g. 01 = 1am, 12 = midday, 13 = 1pm and 00 = midnight. Please contact your supplier for more information on reminder messages.	

Recording reminder messages via a series telephone keypad

To record a reminder message, press:

Then record the message.

Note: (1-6) represents the message slot number. If a message is already recorded under the number entered, this key sequence will replay the message. To re-record a message, the existing number must be deleted first.

To delete a reminder message, press:

Note: (1-6) represents the message slot number.

Configuring reminder messages

PC Connect software is required to program reminder messages such as the time of the reminder message, the duration of the reminder bleep, whether the unit should announce ‘Reminder’ or bleep and the regularity of the reminder (e.g. one off or every day).

Critical visits (Lifeline Connect+ only)

Critical visit monitoring allows scheduled carer visits to users to be monitored and enables alarms to be raised if the schedule is not met. The home unit allows up to six daily carer visits to be monitored. Each carer visit is defined by a visit time and a time window (centred on the visit time), which is an acceptable time window for the visit to occur. The default time window is 60 minutes i.e. the visit should occur between 30 minutes before and 30 minutes after the set visit time. During the time window, the home unit must receive a transmission from a carer trigger (part number 67005/57) otherwise a Carer Non-Arrival alarm will be generated. Critical visits must be programmed via PC Connect.

NOTE: Using the PC Connect programming tool any personal trigger can be defined as a Carer Trigger. The home unit's clock must be set to operate critical visits.

Auto Answer (Lifeline Connect+ only)

The home unit can be set to automatically answer incoming telephone calls using either Caller Line Identification (CLI) or non CLI. The home unit can also be programmed via PC Connect to answer the call as either a normal telephone call (POTS) or with the reminder Interactive voice response menu for setting up and recording reminder messages remotely. If the user has CLI enabled on their telephone line then the unit can be programmed with specific numbers. When the home unit recognises the programmed number it will automatically answer the call.

Non CLI auto answer can be set to single knock or double knock. Setting it to single knock will cause the unit to answer automatically when it is dialled. By setting it to double knock, the unit will only answer if the person ringing the unit rings the unit once and hangs up (before it is answered) then rings back again for a second time within the Double Knock Primed Period limit.

Keyless entry (Lifeline Connect+ only)

This allows a person to attend a property and gain access by the use of a Keyless Access Trigger after an alarm call has been raised on the unit. An electronic door lock must have been fitted to the door for this function to work correctly. For more advice contact the Telecare Helpdesk 0844 855 1564.

Alarm control by time (Lifeline Connect+ only)

This feature allows specific events to be ignored by the Lifeline during a specific time period. This is only relevant to a small number of events, for example, when monitoring room temperatures you may wish to ignore temperatures below the threshold during the night when the resident is likely to be in bed.

The feature can be setup using parameter 92 via either PC Connect or PNC. In PC Connect, go to manual entry then enter the 16 digit parameter as below:

1. first 4 digits HH:MM start time of window when alarms should be raised (24 hour)
2. next 4 digits HH:MM end time of window when alarms should be raised (24 hour)
3. next 4 digits – TT21 event code (See table 4 – trigger type codes)
4. last 4 digits – 0020

For example, to block low temp (event code 4145) alarm calls between 11pm and 7am, the time window for allowing calls should be 7am to 11pm. Therefore the 16 digit code would be 0700230041450020.

NOTE: Events that occur during the blocked time are completely ignored and no record is kept. The home unit's clock must be set correctly.

Virtual Sensors (Lifeline Connect+ only)

Virtual sensor processing is the technique of combining event information from basic sensors to produce more intelligent responses and alarms.

Virtual sensors are pre-defined and the customer defines the behaviour of the sensor within these pre-defined constraints by means of standard parameter based configuration. The home unit supports three types of pre-defined virtual sensors:

- **Inactive client (in room)** - The purpose of this virtual sensor is to generate an alarm if a client has remained in a particular room for longer than a considered safe period of time (configurable). When the client enters the monitored room, this is detected by a sensor (Fast PIR or Door Usage Sensor) and a timer is started. If the timer expires, then an Inactive Client event is generated. If the client leaves the monitored room, before the timeout expires, then this is detected by a suitable sensor and the virtual sensor is reset. The home unit supports four Inactive Client virtual sensors.
- **Bed/Chair Absence Sensor** - The virtual bed/chair absence sensor works like the conventional bed/chair occupancy sensor therefore generating an alarm if a client has got out of bed (or chair) during a monitoring time window (e.g. night) for longer than a considered safe period of time (configurable). When the client gets out of the bed/chair (during the monitoring period), the timer is started. If the timer expires before the client has got back into the bed/chair then a Virtual Bed/Chair Absence event is generated. However the virtual sensor also provides the ability to extend the time period if user activity is detected elsewhere in the property e.g. client has gone downstairs to make a drink, therefore reducing false calls. The home unit supports two Bed/Chair Absence virtual sensors.
- **Property Exit Sensor (PES)** - The virtual property exit sensor works in the same way as the conventional property exit sensor however a simple Fast PIR and door usage sensor can be used to create the complete solution. The sensor generates an alarm if a user has left the property, during a monitoring time window, for longer than a considered safe period of time (configurable). When the client leaves the property (during the monitoring period), the timer is started. If the timer expires before the client has returned to the property then a Virtual PES event is generated. A quick code (650x) is provided to allow a carer etc. to leave the property without causing an alarm to be raised. This quick code is keyed into the series telephone connected to the home unit and disables the Virtual PES for the number of minutes specified by x to give enough time for the carer to leave the property. The home unit supports a single Virtual PES which can be used to monitor multiple doors.

NOTE: The home unit's clock must be set to operate virtual sensors.

ADLife (Lifeline Connect+ only)

The Lifeline Connect+ can be used to provide activities of daily living monitoring using its ADLife functionality. Using ADLife, each time a telecare sensor (see compatible sensors below) is activated the information is stored in the Lifeline Connect+ along with the time of activation. Each night the Lifeline Connect+ then sends this data to the PNC5/6 monitoring centre which sends the collected data over a secure internet connection to the ADLife server where it can be accessed via the ADLife website by authorised users. This allows the carer to view activity trends and helps them to recognise potential declines in health before an incident occurs.

How to set up ADLife

1. Obtain an ADLife ID number from Tunstall – this will be supplied when you take out a 12 month ADLife licence with Tunstall
2. Determine the telephone number(s) of the PNC5/6 which will be used to receive the ADLife data from the unit. This may be the same PNC5/6 that normal alarm calls are sent to but can be a different PNC5/6 if required.

Programming telecare sensors for ADLife

ADLife uses the following standard Tunstall telecare sensors to generate ADL data.

- Electrical Usage Sensor
- Universal Sensor (used for door usage or transmitter for the bed/chair sensor)
- Bed/Chair Occupancy Sensor
- Fast PIR

These should be installed and programmed to the Lifeline Connect+ in the following way:

1. Determine where in the property, the telecare sensors should be fitted
2. Assign the telecare sensors to the unit and ensure the correct location is specified – this can be done using ‘plug and play’ and quick code 4zxx (see page 18) or by using PC Connect.
3. If Bed/Chair sensors with a control unit (part number 41005/13) are being used, then using the PDA programming software, ensure the ‘Enable ADLife data’ box is ticked as shown in the diagram below.

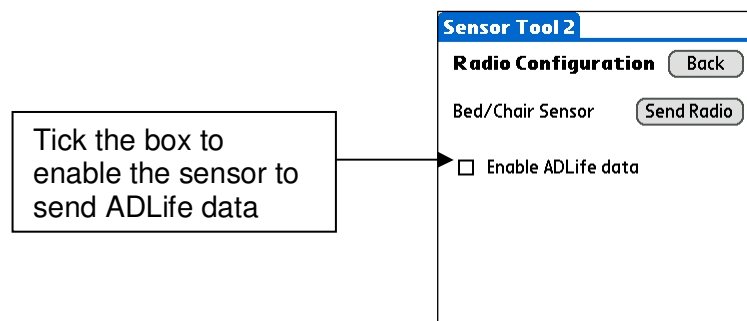

Configuring ADLife

PC Connect is used to configure ADLife. The following steps are required: -

1. **Setting the PNC5/6 number** - If the Lifeline Connect+ is required to send ADLife data to a different PNC5/6 (than normal alarm calls) then it is necessary to set up the alarm numbers and call sequence for ADLife calls. This is done in the standard way using PC Connect:
 - a. Click on the Telephone Numbers and ID icon (on the main PC Connect screen) and enter the number(s) of the PNC5/6 that will receive ADLife calls – in this case numbers 3 and 4. Click OK to exit the screen.

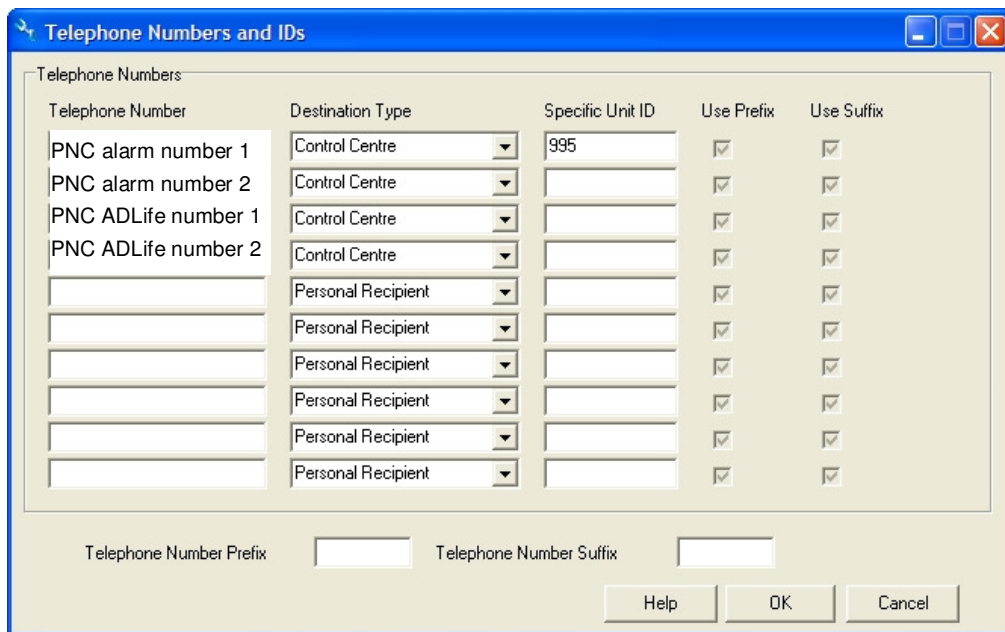

- b. Click on the Call Sequences icon (on the main PC Connect screen) and configure Call Sequence 10 to an appropriate call sequence for the PNC5/6 numbers required to receive ADLife data calls. Click OK to exit the screen.

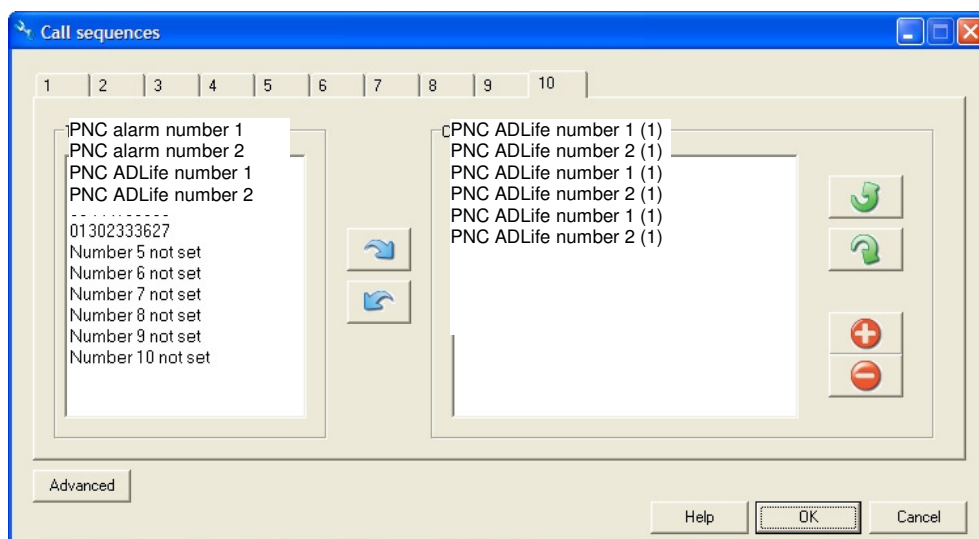

- 2. Configuring the ADLife Data Event** - The next stage is to configure the Lifeline Connect+ home unit's response to the ADLife Data event. Click on the Alarms and Events icon (on the main PC Connect screen), the Alarms Event screen will open. Click the 'Misc' tab and select the ADLife - Data option and then click configure. This will open the ADLife – Data event configuration window. Ensure the Alarm Behaviour box is configured as shown and that the correct Call Sequence is selected. Click OK to exit the screen.

ADLife - Data

TT21 Call Code: 10

Pre-Alarm Delay (seconds): 00

Call Sequence: 10

Alarm Behaviour

Raise alarm call while Home
 Raise alarm call while Away
 Answer incoming call
 Intruder System Input
 Inactivity system input
 Report event as ADLife
 Visual Reassurance
 Audible Reassurance
 Microphone enabled on alarm call
 Speaker enabled on alarm call

Alarm Mode (only used for Ademco Protocol): Standard Alarm

Relay Behaviour

Relay Action: No action

SAG Behaviour

X10 Unit Address: 1
 X10 Action: No action
 Bellman Broadcast:
 Bellman Action: No Action

Buttons: Help, OK, Cancel

3. **Configuring the ADLife Parameter** – Parameter 94 enables/disables ADLife, specifies the ADLife I.D. and the time to send ADLife data. An ADLife icon is available on the main PC Connect screen (V1.17 or later) to access this parameter.
 - a. Click on the ADLife icon (on the main PC Connect screen) which will open the ADLife Configuration screen.

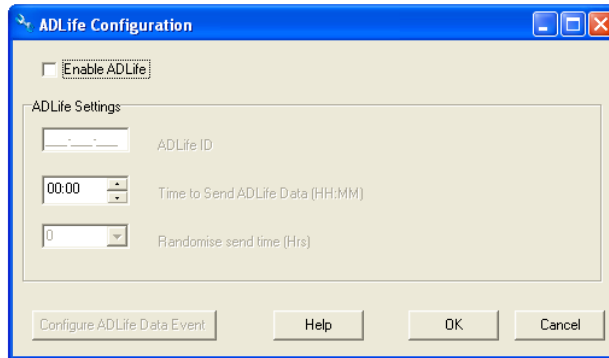

- b. Tick the Enable ADLife box
 - c. Enter the ADLife ID (supplied by Tunstall)
 - d. Enter the time at which the ADLife data will be sent to the PNC5/6 monitoring centre. This is recommended to be between 03:00 and 04:00 (24 hour format)
 - e. Enter the randomise send time. This programs the unit to send its data +/- 0, 1 or 2 hours from the actual send time previously set.
 - f. Click OK to confirm the changes
 - g. Set the correct time/date on the unit using the Time and Date icon (on the main PC Connect screen)
 - h. Click Write, then either 'Write only modified parameters' or 'Write all parameters except date and time'.
4. **Completing the ADLife installation**
 - a. Use the quick code (6550) to clean out any ADLife data from the unit. This will remove any data collected as a result of testing sensors etc. The unit will send ADLife data (within the time window specified by Parameter 94) and this can be viewed the next day on the ADLife Server.
 - b. Test the setup – a quick code (6551) is also available to force the unit to make an ADLife data call immediately, this data will then be presented on the ADLife website within 5 minutes. If the data doesn't appear check that the installation and configuration process has been followed correctly.

Table 1 – TT92 Codes

TT92 Code	Associated Call Code	Text	TT92 Code	Associated Call Code	Text
00		Unit	51		Living room
01	2	First resident personal	52		Dining room
02	2	Second resident personal	53		Study
03	2	Third resident personal	54		Second living room
04		Unspecified location	55	6	ROM 4 event 1
05		Unspecified location	56	6	ROM 4 event 2
06	9	Bogus Caller	57	8	Door usage auto low bat
07	3	CO Detector activation	58	6	ROM 4 event 4
08	8	CO Detector auto low bat	59	8	ROM 4 auto low bat
09	6	Intruder tamper	60		Hall/stairs not spec
10	8	Arm/Disarm auto low bat	61		Hall
11	6 or 8	Flood Detector 2	62		Landing
12	6 or 8	Flood Detector 3	63		Stairs
13	6 or 8	Flood Detector 4	64		Bath high level
14	6 or 8	Flood Detector 5	65	8	Med reminder no ack
15	6	Bed/chair not in by	66	8	Auto presence failed
16	6	Bed/chair not up by	67	6	Incontinence event
17	6	Bed/chair absent	68	8	Incontinence auto low bat
18	6	Bed/chair other	69	6	Bath high temp
19	8	Bed/chair auto low bat	70	6	Bath low temp
20		Bedroom not specified	71		Garage 1
21		Master bedroom	72		Garage 2
22		Second bedroom	73		Front garden
23		Other bedroom	74		Back garden
24		Other bedroom	75	6	Epilepsy
25	6	ROM 1 event 1	76	6	Epilepsy spare
26	6	ROM 1 event 2	77	8	Epilepsy auto low bat
27	6	ROM 1 event 3	78	8	Carer arrived
28	6	ROM 1 event 4	79	6	Carer not arrived
29	8	ROM 1 auto low bat	80	8	Bath auto low bat
30		Bathroom WC not specified	81	6	Dose missed
31		Main bathroom	82	6	Med dispenser fault
32		Second bathroom	83	8	Med dispenser auto low bat
33		Downstairs WC	84	6	CO end of life
34		Outside WC	85	6	CO fault
35	6	ROM 2 event 1	86	3	Temp rise
36	6	ROM 2 event 2	87	6	Low temp
37	8	Electrical Usage auto low bat	88	8	Temp sensor fault
38	6	ROM 2 event 4	89	3	High temp
39	8	ROM 2 auto low bat	90	8	Temp sensor auto low bat
40		Kitchen not spec	91	8	Fall detector auto low bat
41		Main kitchen area	92	2 or 5	Fall detector button press
42		Second kitchen area	93	2 or 5	Fall detector fall
43		Other kitchen area	94	6 or 8	Flood detector 1
44		Other kitchen area	95	3	Gas detector activated
45	6	ROM 3 event 1	96	8	Gas detector auto low bat
46	6	ROM 3 event 2	97	9	Door left open
47	6	ROM 3 event 3	98	9	Property exit
48	6	ROM 3 event 4	99	8	Property exit auto low bat
49	8	ROM 3 auto low bat			
50		Living room area not spec			

Table 2 - TT21 Location Codes

TT21 Code	Location	TT21 Code	Location
00	Blank	50	Living area
01	Resident 1	51	Living room
02	Resident 2	52	Dining room
03	Resident 3	53	Study
04	Unspecified	54	Living room 2
05	Unspecified	55	Living area
06	Unspecified	56	Living area
07	Unspecified	57	Living area
08	Unspecified	58	Living area
09	Unit	59	Living area
10	Kettle	60	Hall/stairs
11	Television	61	Hall
12	Stove	62	Landing
13	Microwave	63	Stairs
14	Toaster	64	Hall/stairs
15	Vacuum	65	Hall/stairs
16	Appliance 1	66	Hall/stairs
17	Appliance 2	67	Hall/stairs
18	Appliance 3	68	Hall/stairs
19	Appliance 4	69	Hall/stairs
20	Bedroom	70	Garden/garage
21	Master bedroom	71	Garage 1
22	Second bedroom	72	Garage 2
23	Third bedroom	73	Front garden
24	Fourth bedroom	74	Back garden
25	Other bedroom	75	Shed
26	Other bedroom	76	Garden/garage
27	Other bedroom	77	Garden/garage
28	Other bedroom	78	Garden/garage
29	Other bedroom	79	Garden/garage
30	Bathroom /WC	80	Front door
31	Main bathroom	81	Back door
32	Second bathroom	82	Fridge door
33	Downstairs WC	83	Medicine cabinet
34	Outside toilet	84	Wardrobe door
35	En- suite	85	Food cupboard
36	Shower	86	Other door 1
37	Other bathroom	87	Other door 2
38	Other bathroom	88	Other door 3
39	Other bathroom	89	Other door 4
40	Kitchen	90	Unspecified
41	Main Kitchen	91	Unspecified
42	Second kitchen	92	Unspecified
43	Other kitchen	93	Unspecified
44	Other kitchen	94	Unspecified
45	Other kitchen	95	Unspecified
46	Other kitchen	96	Unspecified
47	Other kitchen	97	Unspecified
48	Other kitchen	98	Unspecified
49	Other kitchen	99	Unspecified

Table 3 - Trigger Type Codes

Trigger	Type Code	Trigger	Type Code
Personal + ALB	01	Carer Trigger	15
Personal + AP	02	ROM #1	16
Temperature Extreme Sensor	03	ROM #2	17
Flood Detector	04	ROM #3	18
CO Detector	05	ROM #4	19
Smoke Detector	06	Nat Gas	20
Door Usage Sensor	07	Property Exit	21
Pressure Mat	08	Arm/Disarm	22
Radio Pull Cord	09	Bogus Caller	23
Enuresis Sensor	10	Electrical Usage	24
Bed/Chair Sensor	11	Medication Dispenser	26
PIR Entry/Exit	12	Bath Sensor	27
Fall Detector	13	Epilepsy	28
PIR Standard	14	Zoning Trigger	29

Table 4 - TT21 Call Codes

Event	Call Code	4 Digit Code	Event	Call Code	4 Digit Code
Personal Trigger activation	AA		PES AP	CR	
Personal Trigger activation (LB)	Aa		PES AP (LB)	Cr	
Personal Trigger AP	AB		PES ALB	D6	
Personal Trigger AP (LB)	Ab		PES AP Fail	D7	
Personal Trigger ALB	A0		Arm/Disarm activation	CS	
Personal Trigger AP Fail	A1		Arm/Disarm activation (LB)	Cs	
TES High Temp	AC		Arm/Disarm AP	CT	
TES High Temp (LB)	Ac		Arm/Disarm AP (LB)	Ct	
TES Fault	AD		Arm/Disarm ALB	D8	
TES Fault (LB)	Ad		Arm/Disarm AP Fail	D9	
TES Low Temp	AE	4145	Bogus Caller activation	CU	
TES Low Temp (LB)	Ae	4165	Bogus Caller activation (LB)	Cu	
TES Temp Rise	AF		Bogus Caller AP	CV	
TES Temp Rise (LB)	Af		Bogus Caller AP (LB)	Cv	
TES AP	AG		Bogus Caller ALB	E0	
TES AP (LB)	Ag		Bogus Caller AP Fail	E1	
TES ALB	A2		Electrical Usage Sensor ON	CW	
TES AP Fail	A3		Electrical Usage Sensor ON (LB)	Cw	
Flood Detector activation	AH		Electrical Usage Sensor OFF	CX	
Flood Detector activation (LB)	Ah		Electrical Usage Sensor OFF (LB)	Cx	
Flood Detector AP	AI		Electrical Usage Sensor AP	CY	
Flood Detector AP (LB)	Ai		Electrical Usage Sensor AP (LB)	Cy	
Flood Detector ALB	A4		Electrical Usage Sensor ALB	E2	
Flood Detector AP Fail	A5		Electrical Usage Sensor AP Fail	E3	
CO Detector activation	AJ		Medication Dispenser Dose Missed	CZ	
CO Detector activation (LB)	Aj		Medication Dispenser Dose Missed (LB)	Cz	
CO Detector EOL	AK		Medication Dispenser Device Fault	DA	
CO Detector EOL (LB)	Ak		Medication Dispenser Device Fault (LB)	Da	
CO Detector fault	AL		Medication Dispenser Dose Taken	DB	
CO Detector fault (LB)	Al		Medication Dispenser Dose Taken (LB)	Db	
CO Detector AP	AM		Medication Dispenser AP	DC	
CO Detector AP (LB)	Am		Medication Dispenser AP (LB)	Dc	
CO Detector ALB	A6		Medication Dispenser ALB	E4	
CO Detector AP Fail	A7		Medication Dispenser AP Fail	E5	
Smoke Detector activation	AN		Bath Sensor High Level	DD	
Smoke Detector activation (LB)	An		Bath Sensor High Level (LB)	Dd	
Smoke Detector AP	AO		Bath Sensor High Temp	DE	
Smoke Detector AP (LB)	Ao		Bath Sensor High Temp (LB)	De	
Smoke Detector ALB	A8		Bath Sensor Low Temp	DF	
Smoke Detector AP Fail	A9		Bath Sensor Low Temp (LB)	Df	
Door Usage opening	AQ	4151	Bath Sensor AP	DG	
Door Usage opening (LB)	Aq	4171	Bath Sensor AP (LB)	Dg	
Door Usage closing	AR	4152	Bath Sensor ALB	E6	
Door Usage closing (LB)	Ar	4172	Bath Sensor AP Fail	E7	
Door Usage AP	AS	4153	Epilepsy Sensor activation	DH	
Door Usage AP (LB)	As	4173	Epilepsy Sensor activation (LB)	Dh	
Pressure Mat activation	AT	4154	Natural Gas Detector activation (LB)	Cn	
Pressure Mat activation (LB)	At	4174	Natural Gas Detector AP	CO	
Pressure Mat AP	AU	4155	Natural Gas Detector AP (LB)	Co	
Pressure Mat ALB	B2	4232	Natural Gas Detector ALB	D4	
Pressure Mat AP Fail	B3	4233	Natural Gas Detector activation	CN	
Pullcord activation	AV		Natural Gas Detector AP Fail	D5	
Pullcord activation (LB)	Av		Epilepsy Sensor other (LB)	Di	
Pullcord AP	AW		Epilepsy Sensor AP	DJ	
Pullcord AP (LB)	Aw		Epilepsy Sensor AP (LB)	Dj	
Pullcord activation	AV		Epilepsy Sensor ALB	E8	
Pullcord activation (LB)	Av		Epilepsy Sensor AP Fail	E9	
Enuresis Sensor activation	AX	4158	Zoning Trigger Zone 1	DK	
Enuresis Sensor activation (LB)	Ax	4178	Zoning Trigger Zone 1 (LB)	Dk	
Enuresis Sensor ALB	B6	4236	Zoning Trigger Zone 2	DL	
Bed/Chair Not in	AZ		Zoning Trigger Zone 2 (LB)	DI	
Bed/Chair Not in (LB)	Az		Zoning Trigger AP	DM	
Door Usage ALB	B0	4230	Zoning Trigger AP (LB)	Dm	
Door Usage AP Fail	B1	4231	Zoning Trigger ALB	F0	

Installation and Programming Guide

Door Call	KA		Zoning Trigger AP Fail	F1	
Pullcord ALB	B4		Red Button	HA	
Pullcord AP Fail	B5		Cancel Button	Ha	
Bed/Chair Not up	BA		Door Open Button	HC	
Bed/Chair Not up (LB)	Ba		Away Button	Hc	
Bed/Chair Absence	BB		Function Button #4	HD	
Bed/Chair Absence (LB)	Bb		Intruder Alarm	IA	
Bed/Chair Other	BC		Inactivity Alarm	Ia	
Bed/Chair Other (LB)	Bc		Periodic Call	IB	
Bed/Chair MIDAS IN	BD		Firemans Switch	Ib	
Bed/Chair MIDAS IN (LB)	Bd		Fire Panel Input	IC	
Bed/Chair MIDAS OUT	BE		Medical Reminder - No Ack	Ic	
Bed/Chair MIDAS OUT (LB)	Be		ADLife - Data	ID	
Bed/Chair AP	BF		Virtual Bed/Chair #1 Absence	Id	
Bed/Chair AP (LB)	Bf		Virtual Bed/Chair #1 Client In	IE	
Bed/Chair ALB	B8		Virtual Bed/Chair #1 Client Out	Ie	
Bed/Chair AP Fail	B9		Virtual Bed/Chair #2 Absence	IF	
PIR (E/E) activation	BG		Virtual Bed/Chair #2 Client In	If	
PIR (E/E) activation (LB)	Bg		Virtual Bed/Chair #2 Client Out	IG	
PIR (non E/E) activation	BH		Virtual Inactive Client #1	Ig	
PIR Tamper	BI		Virtual Inactive Client #2	IH	
PIR AP	BM		Virtual Inactive Client #3	Ih	
PIR AP (LB)	Bm		Virtual Inactive Client #4	Ii	
PIR ALB	C0		Virtual PES	ii	
PIR AP Fail	C1		H/W Input #1	IJ	
Fall Detector button	BN		H/W Input #2	Ij	
Fall Detector button (LB)	Bn		SM Low Temp Input (Code 6)	IK	
Fall Detector fall	BO		SM Auxiliary Input (Code 0)	Ik	
Fall Detector fall (LB)	Bo		Mains Fail	JA	
Fall Detector AP	BP		Mains Restore	Ja	
Fall Detector AP (LB)	Bp		System Battery Low	JB	
Fall Detector ALB	C2		Auto Presence Failure	Jb	
Fall Detector AP Fail	C3		Auto Low Battery	JC	
Carer Trigger activation	BQ		Telephone Line #1 Fail	Jc	
Carer Trigger activation (LB)	Bq		Telephone Line #1 Restore	JD	
Carer Trigger AP	BR		Telephone Line #2 Fail	Jd	
Carer Trigger AP (LB)	Br		Telephone Line #2 Restore	JE	
Carer Trigger ALB	C4		Pager Fault	Je	
Carer Trigger AP Fail	C5		CCFP Paging Fault	JF	
ROM # 1 Event #1	BS		Fault - Radio System	Jf	
ROM # 1 Event #1 (LB)	Bs		Fault - Poll Failure	JG	
ROM # 1 Event #2	BT		Fault - Door Panel Keypad	Jg	
ROM # 1 Event #2 (LB)	Bt		Fault - Failed To Contact ARC	JH	
ROM # 1 Event #3	BU		Fault - SAG Failure	Jh	
ROM # 1 Event #3 (LB)	Bu		Fault #1 – EEPROM Fault	J1	
ROM # 1 Event #4	BV		Fault #2 – Stuck Key Fault	J2	
ROM # 1 Event #4 (LB)	Bv		Fault #3	J3	
ROM # 1 AP	BW		Fault #4	J4	
ROM # 1 AP (LB)	Bw		Fault #5	J5	
ROM # 2 Event #1	BX		Fault #6	J6	
ROM # 2 Event #1 (LB)	Bx		Manual Test Alarm	J7	
ROM # 2 Event #2	BY		Fault - Unit Failure	J8	
ROM # 2 Event #2 (LB)	By		Battery Charged	J9	
ROM # 2 Event #3	BZ		Fault #10	J0	
ROM # 2 Event #3 (LB)	Bz		Ringing start	Ka	
ROM # 1 ALB	C6		Ringing end	KB	
ROM #1 AP Fail	C7		Unknown Alarm	Kb	
ROM # 2 Event #4	CA		Away State entry	Kd	
ROM # 2 Event #4 (LB)	Ca		Home State entry	KE	
ROM # 2 AP	CB		Call Raised	Ke	
ROM # 2 AP (LB)	Cb		Call Selected	KF	
ROM # 2 ALB	C8		Call Cleared	Kf	
ROM #2 AP Fail	C9		Speech Module Selected	KG	
ROM # 3 Event #1	CD		System onsite	Kg	
ROM # 3 Event #1 (LB)	Cd		System offsite	KH	
ROM # 3 Event #2	CE		Dialling complete	Kh	
ROM # 3 Event #2 (LB)	Ce		Protocol complete	KI	
ROM # 3 Event #3 (LB)	Cf		TT New Acceptor Code 0 (D)	Ki	
ROM # 3 Event #4	CG		TT New Acceptor Code 3 (D/G)	KJ	
ROM # 3 Event #4 (LB)	Cg		TT New Acceptor Code 6 (D)	Kj	
ROM # 3 AP	CH		TT New Acceptor Code A (D)	KL	
ROM # 3 AP (LB)	Ch		TT New Acceptor Code B (D)	KI	

ROM # 4 Event #1	CI		TT New Acceptor Code C (D)	KM	
ROM # 4 Event #1 (LB)	Ci		TT New Acceptor Code D (D)	Km	
ROM # 4 Event #2	CJ		TT New Acceptor Code * (D)	KN	
ROM # 4 Event #2 (LB)	Cj		Ringing start	Ka	
ROM # 4 Event #3	CK		Ringing end	KB	
ROM # 4 Event #3 (LB)	Ck		Unknown Alarm	Kb	
ROM # 4 Event #4	CL		Call Raised	Kd	
ROM # 4 Event #4 (LB)	Cl		Call Selected	KE	
ROM # 4 AP	CM		Call Cleared	Ke	
ROM # 4 AP (LB)	Cm		Speech Module Selected	KF	
ROM # 3 ALB	D0		System onsite	Kf	
ROM #3 AP Fail	D1		Dialling complete	Kg	
ROM # 4 ALB	D2		Intruder system armed	K1	
ROM #4 AP Fail	D3		Intruder system disarmed	K2	
PES Door Left Open	CP		Carer Left	K3	
PES Door Left Open (LB)	Cp		Intruder Timeout	K4	
PES Client Wandered	CQ		Keyless Access	K5	
PES Client Wandered (LB)	Cq		Concierge Call	K6	

Technical Details

Weight:	650g
Dimensions:	195 x 215 x 36mm (WxLxD)
Mains power:	230v ac 13A electrical socket
Stand-by battery:	1200mAh capacity (continually internally charged)
Back-up time:	30 hours of stand-by operation with one 30 minute alarm call (minimum expected at date of purchase and when fully charged)
Radio frequency:	869.2125MHz, compliant with the European Social Alarm frequency band
REN:	1
External connections:	3m telephone line cord with type BS6312 plug Plug top transformer with 3m cable

Environmental

Temperature:	Operating temperature (to perform to full specification) = 0°C to 45°C, storage = -10°C to 50°C
Humidity:	Operating relative humidity (non condensing to perform to full specification) = 0 to 80%, storage relative humidity (non condensing) = 0 to 93%

Standards

EMC:	EN55022: 1998, EN55024:1998, EN50130-4: 1995, EN301 489-1: 2008, EN301 489-3:2002
Safety:	EN60950:2000
Radio:	ETSI EN300 220-2: 2010 Category 1
CE:	Compliant
Social alarm:	EN50134-1:2002, EN50134-2:1999 (trigger device), EN50134-3:2001
Design, Manufacture, Installation and Service:	ISO9001:2008

Declaration of Conformity

We, Tunstall declare that this social alarm equipment is in compliance with the essential requirements and other relevant provisions of the R&TTE Directive 1999/5/EC.



www.tunstallhealth.com

A member of the Tunstall Healthcare Group

Our policy of continual development means that product specification and appearance may change without notice. Tunstall does not accept any responsibility for any errors or omissions contained in this document. © 2011 Tunstall Group Ltd.

® TUNSTALL, LIFELINE and AMIE are registered trademarks

Tunstall Group Limited, Whitley Lodge, Whitley Bridge, Yorkshire DN14 0HR
Tel: 01977 661234 Fax: 01977 662450 Email: enquiries@tunstall.co.uk